

n° 1

news

ceramic \ design book



hand made — in Italy.

cielo

n° 1

hand made — in Italy.

cielo

intro 06-09
catino tondo 10-19
catino ovale 20-31
catino doppio 32-43
catino rettangolare 44-55
milano 56-67
narciso vanity 68-79
narciso mini 80-89
narciso doppio 90-97
siwa 98-105
kyros 106-113
delfo 114-119
sella 120-125
elle 126-139
plinio 140-147
modulo 148-152
multiplo 153-181
accessori 182-199
vasche 200-211
specchi 212-265
i colori 266-283

Alla base dell'unicità del prodotto di design Cielo risiede la capacità imprenditoriale di conciliare un prodotto industriale di altissima qualità con la volontà di non perdere la tradizione della lavorazione fatta a mano. La lavorazione della ceramica, in tutte le sue molteplici declinazioni, è di fatto una delle più antiche pratiche di trasformazione della materia prima naturale in oggetto d'uso.

At the basis of Cielo product design uniqueness, lies the skill in conciliating a top-notch industrial product with the intention in not losing the handmade working tradition. The ceramic manufacturing, in its every multiple inflection is, as a matter of facts, one of the most ancient practice of transforming raw material in a usable object.



«...design e tradizione.
Fatto a mano in Italia
design and tradition.
Handmade in Italy...»

La Ceramica è la materia nobile per eccellenza, usata e diffusa da secoli per oggetti di grande valore. Un materiale difficile da plasmare e controllare, ma che sa regalare, a chi riesce a "DOMARLA", prodotti unici per bellezza, qualità e resistenza. La missione di CIELO è quella di portare la ceramica oltre i limiti conosciuti, attraverso forme, dimensioni, spessori, superfici, colori. I nostri prodotti esprimono, esaltano e fondono una straordinaria ed unica capacità di lavorare la Ceramica, ad un design contemporaneo e senza tempo.

Ceramic is a noble material in the true sense of the word, used over the centuries and around the world to make the finest objects. This material is difficult to shape and control, but to those who know how to tame it, it returns the gift of things unique in their beauty, quality, and strength. Cielo's mission is to bring ceramic beyond the bounds of the known in an exploration of shapes, sizes, thicknesses, surfaces, and colors. Our products expertly merge our peerless ability to work with ceramic material with contemporary, timeless designs to achieve extraordinary results.

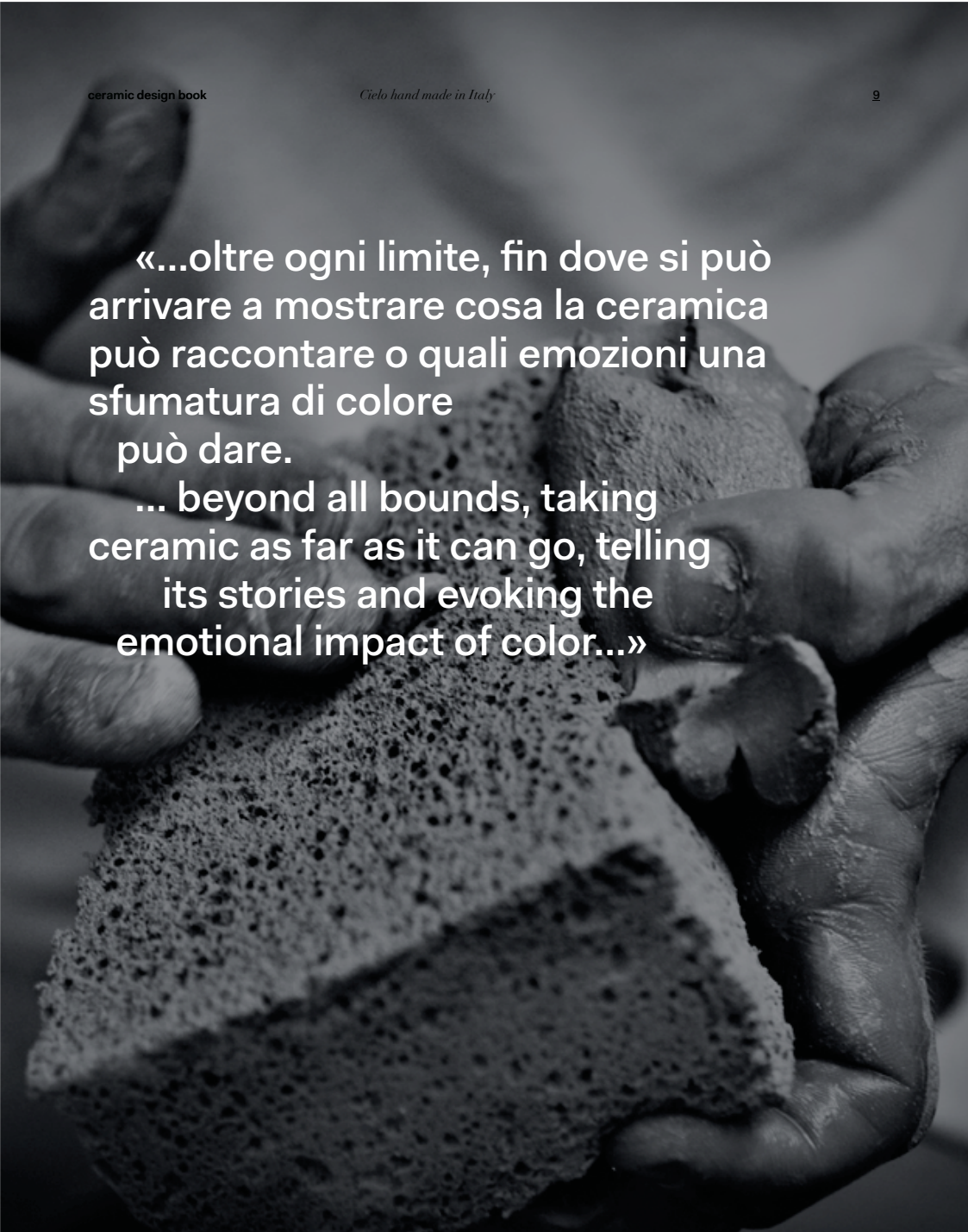

«...oltre ogni limite, fin dove si può arrivare a mostrare cosa la ceramica può raccontare o quali emozioni una sfumatura di colore può dare.

... beyond all bounds, taking ceramic as far as it can go, telling its stories and evoking the emotional impact of color...»

catino tondo.

Una geometria pura che si adatta a qualsiasi forma e dimensione di spazio. “Cercavamo oggetti ricchi di significato... applicando il filtro della contemporaneità volevamo raccontare la bellezza della memoria”

A pure geometry that adapts to any form and dimension in space. “We were seeking things with a wealth of meaning... We wanted to express the beauty of memory through the filter of contemporary style”





lavabo \ washbasin: polvere
struttura \ framework: nero matt
piano \ shelf: marmo nero marquina
specchio ovale \ oval mirror



lavabo \ washbasin: lavagna
struttura \ framework: nero matt
piano in ceramica \ ceramic shelf: lavagna
specchio oval box \ oval box mirror

lavabo \ washbasin: polvere
 struttura \ framework:
 bronzo spazzolato
 piano \ shelf: polvere
 specchio pluto \ pluto mirror
 porta sapone \ soap holder
 portasciugamani \ towel rail





lavabo \ washbasin: talco
struttura \ framework: cemento
piano \ shelf: marmo nero marquina
specchio ovale \ oval mirror
porta sapone \ soap holder
vasca cibeles \ cibeles bathtub:
cemento

Materiali e finiture \ Materials and finishes

Catino Tondo 50 con piano \ with shelf - Ø50 x h83

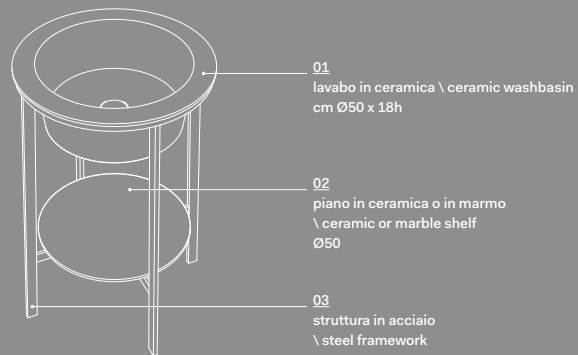

01 lavabo \ washbasin

materiale \ material:
ceramica \ ceramic

finiture \ finishes:
Le Terre di Cielo



02 piano \ shelf

materiale \ material:
ceramica o marmo \
ceramic or marble

finiture \ finishes:
Le Terre di Cielo



finiture \ finishes:
Marmo \ Marble



03 struttura \ framework

materiale \ material:
acciaio verniciato \
painted steel

verniciature \ coatings



catino ovale.

L'ampio bacino dal disegno ellittico è la sintesi perfetta di eleganza e funzionalità. "Abbiamo voluto realizzare dei prodotti che valorizzassero l'anima artigianale dell'azienda, la sua vocazione a proporre oggetti che fossero la dimostrazione dell'eccellenza nella lavorazione della ceramica, che solo Cielo ha"

The broad basin of the elliptical design is the perfect synthesis of elegance and practicality. "Our aim was to realize some product that could valorize the artisan spirit of the factory and its vocation for presenting items that are the expression of excellence in ceramics, the one that only Cielo can get"



lavabo \ washbasin: talco
struttura \ framework: nero matt
piano \ shelf: brina
specchio oval box \ oval box mirror
elemento porta sapone e
portasciugamani \
soap holder and towel rail element

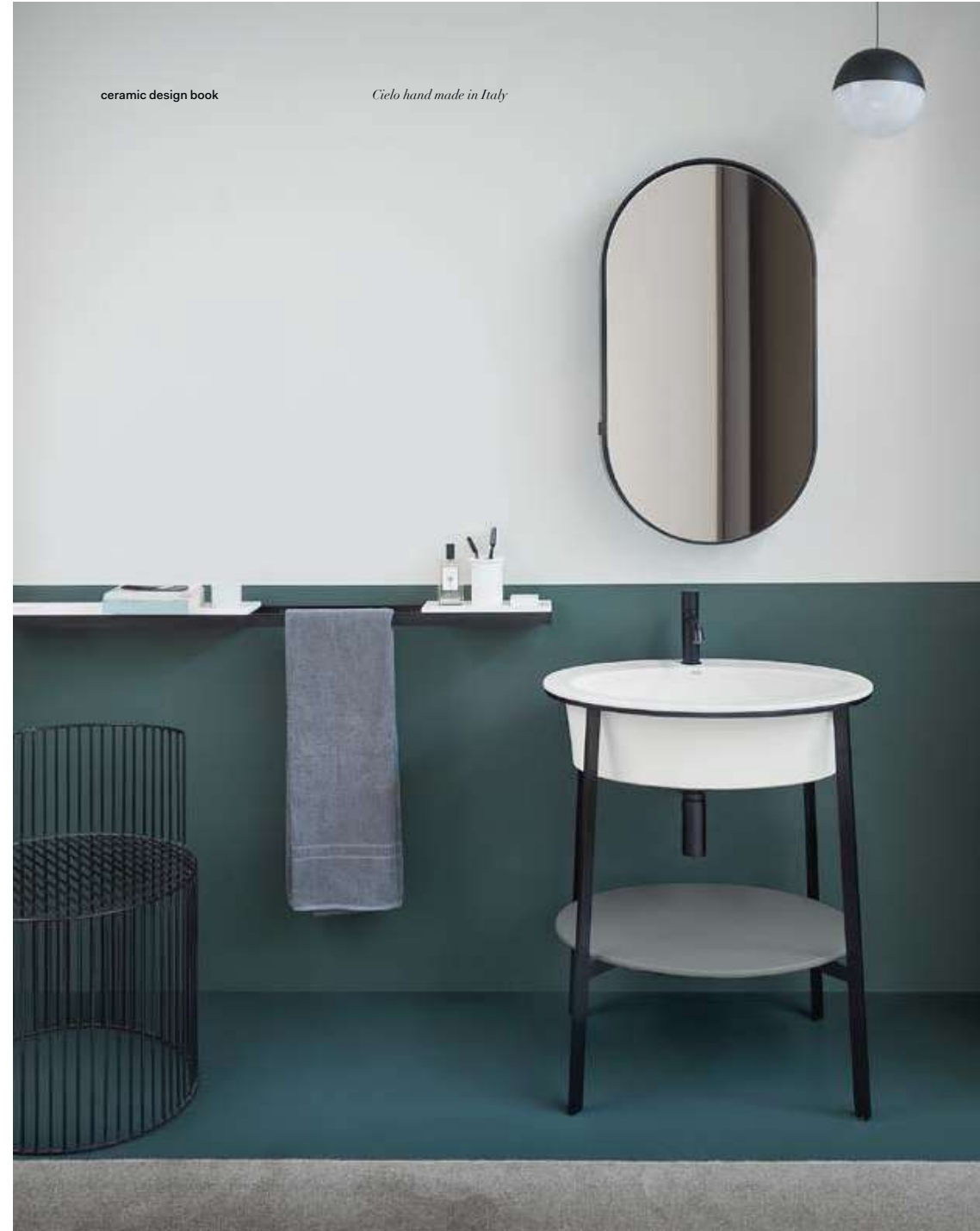



lavabo \ washbasin: cipria
struttura \ framework: bronzo spazzolato
cassetto \ drawer: pomice
specchio ovale \ oval mirror
porta sapone \ soap holder
sacca portabiancheria \ laundry bag



lavabo \ washbasin: polvere
struttura \ framework: nero matt
piano \ shelf: marmo bianco carrara
oval box \ oval box mirror
porta sapone \ soap holder



lavabo \ washbasin: talco
struttura \ framework: nero matt
piano \ shelf: marmo bianco carrara
specchio oval box \ oval box mirror
porta sapone \ soap holder

Materiali e finiture Materials and finishes

Catino Ovale 70 con piano \ with shelf - cm 70 x 50 x h83

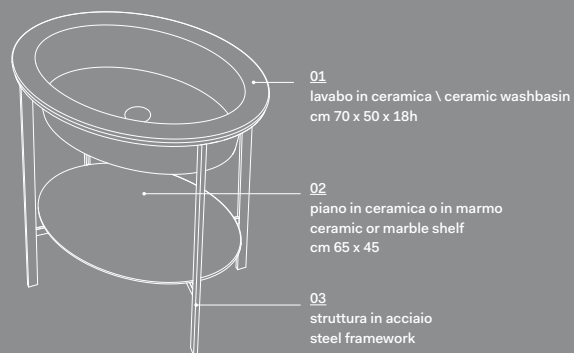

Catino Ovale 70 con cassetto \ with drawer - cm 70 x 50 x h83

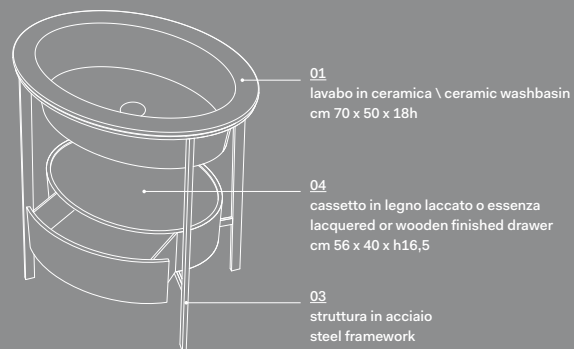

01 lavabo \ washbasin

materiale \ material:
ceramica \ ceramic

finiture \ finishes:
Le Terre di Cielo



02 piano \ shelf

materiale \ material:
ceramica o marmo \
ceramic or marble

finiture \ finishes:
Le Terre di Cielo



finiture \ finishes:
marmo \ marble



03 struttura \ framework

materiale \ material:
acciaio verniciato \
painted steel

verniciature \ coatings



04 cassetto \ drawer

materiale \ material:
legno laccato o in essenza
\ lacquer or wooden finish

laccature \ lacquers



essenze \ wooden finishes

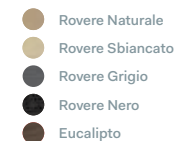

Materiali e finiture Materials and finishes

Catino Ovale 70 monoforo predisposto 3 fori, con piano \ with 1 hole prepared 3 holes, with shelf - cm 70 x 50 x h83

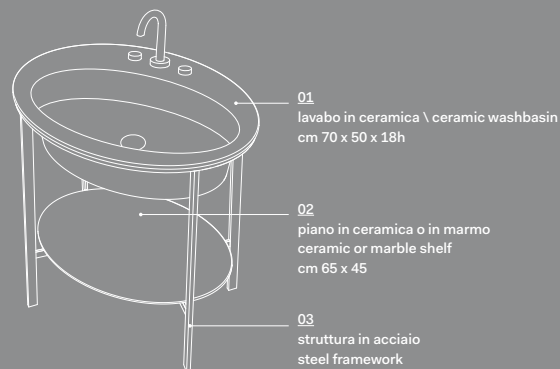

Catino Ovale 70 monoforo predisposto 3 fori, con cassetto with 1 hole prepared 3 holes, with drawer - cm 70 x 50 x h83

**01** lavabo \ washbasin

materiale \ material:
ceramica \ ceramic

finiture \ finishes:
Le Terre di Cielo

**02** piano \ shelf

materiale \ material:
ceramica o marmo \
ceramic or marble

finiture \ finishes:
Le Terre di Cielo



finiture \ finishes:
marmo \ marble

**03** struttura \ framework

materiale \ material:
acciaio verniciato \
painted steel

verniciature \ coatings

**04** cassetto \ drawer

materiale \ material:
legno laccato o in essenza
\ lacquer or wooden finish

laccature \ lacquers



essenze \ wooden finishes



catino doppio.

Unico elemento con due lavabi dove la diversità delle finiture esalta la bellezza della forma. Integrano armoniosamente strutture in acciaio nelle finiture Nero Matt Bronzo spazzolato e Cemento, lavabi in ceramica nelle 16 finiture della gamma Terre di Cielo o in bianco lucido e piani in legno, marmo o un comodo cassetto contenitore.

A unique element with two washbasins where the diversity of the finishings bring out the beauty of the form. Harmonically combines frameworks made of steel and available in Nero Matt, Bronzo Spazzolato or Cemento with ceramic washbasins in 16 colours of Terre di Cielo range or glossy white and wood or marble shelves as well as a convenient storage drawer.

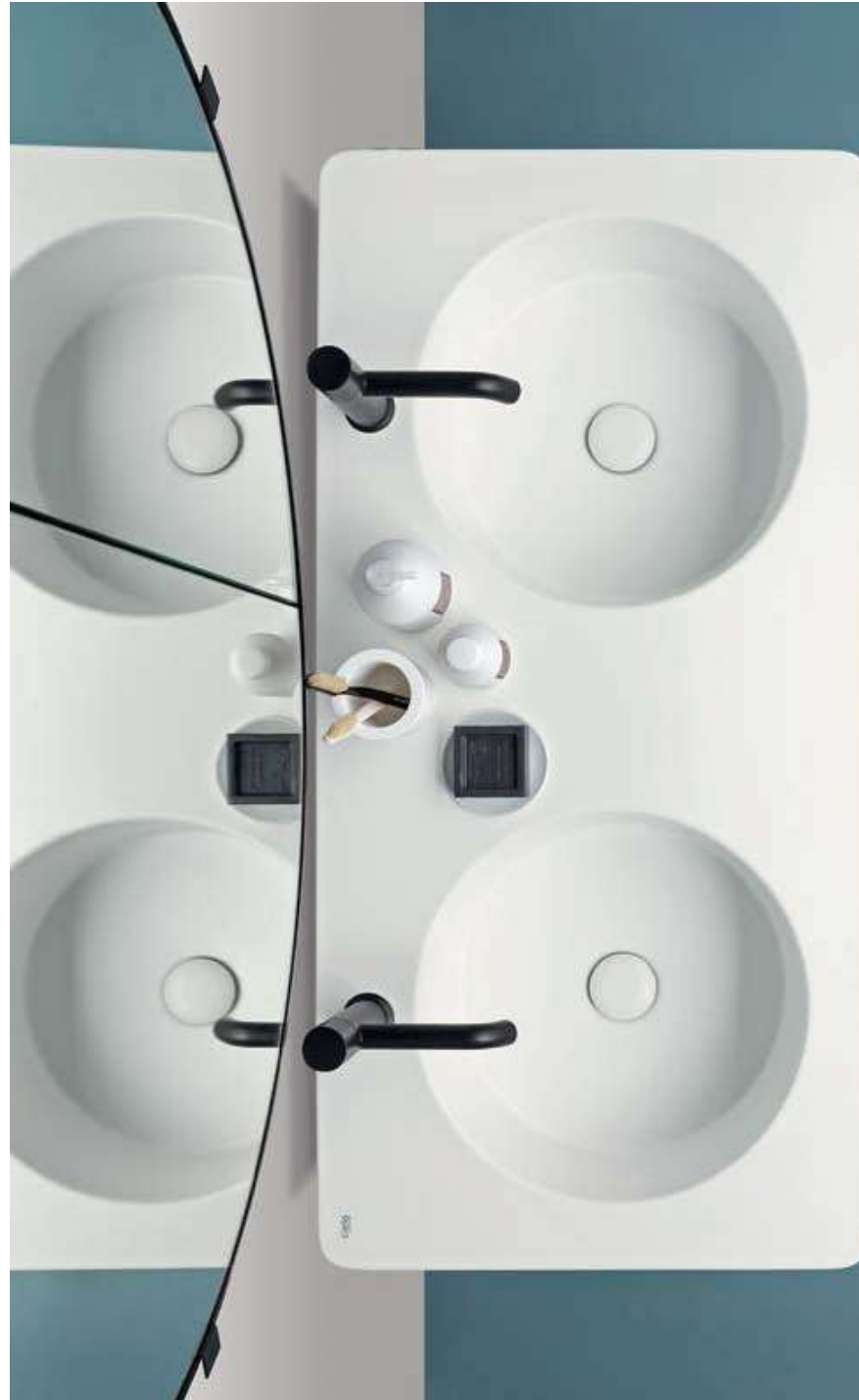



lavabo \ washbasin: talco
struttura \ framework: nero matt
cassetto \ drawer: cemento





lavabo \ washbasin: basalto
struttura \ framework: nero matt
piano \ shelf: marmo bianco carrara
specchio round box \ round box mirror
portasciugamani \ towel rail
vasca cibeles \ cibeles bathtub: basalto
wc e bidet sospesi shui comfort \ wall-hung
shui comfort wc e bidet: basalto



lavabo \ washbasin: talco
struttura \ framework: nero matt
cassetto \ drawer: avena
specchio round box \ round box mirror
wc e bidet sospesi shui comfort \
shui comfort wall-hung wc e
bidet: basalto



lavabo \ washbasin: basalto
struttura \ framework: nero matt
cassetto \ drawer: eucalipto
specchio round box \ round box mirror

Materiali e finiture \ Materials and finishes

Catino Doppio 110 con piano \ with shelf - cm 110 x 58,5 x h83

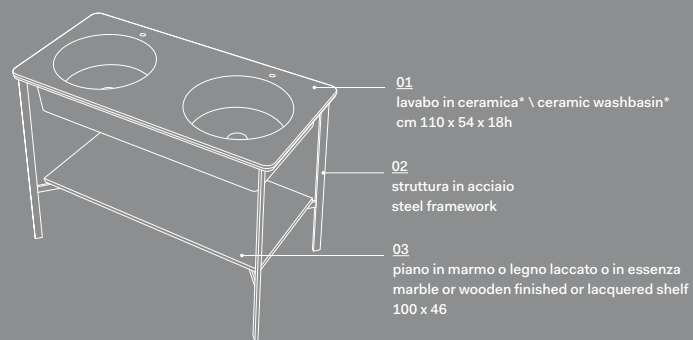

Catino Doppio 110 con cassetto \ with drawer - cm 110 x 58,5 x h83

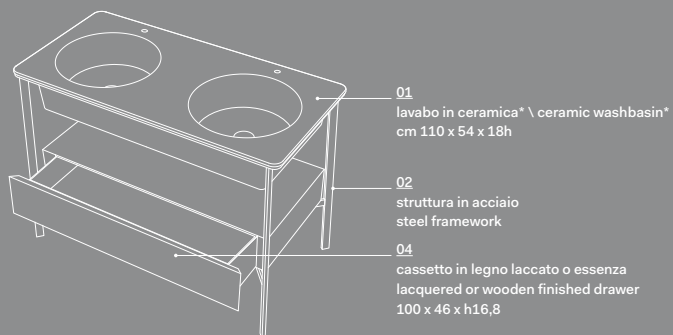

*lavabo con 2 fori predisposto 6 fori \ *washbasin with 2 holes prepared 6 holes

01 lavabo \ washbasin

materiale \ material:
ceramica \ ceramic

finiture \ finishes:
Le Terre di Cielo



02 struttura \ framework

materiale \ material:
acciaio verniciato \
painted steel

verniciature \ coatings



03 piano \ shelf

materiale \ material:
legno laccato o in essenza,
marmo \ lacquer, wooden or
marble finish

laccature \ lacquers

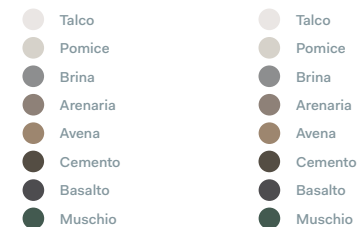

essenze \ wooden finishes



finiture \ finishes:
marmo \ marble



04 cassetto \ drawer

materiale \ material:
legno laccato o in essenza
\ lacquer or wooden finish

laccature \ lacquers



essenze \ wooden finishes



Infinite possibilità di personalizzazione \ Infinite customized solutions

catino rettangolare.

Evoluzione della collezione I Catini, il modello rettangolare ricerca la funzionalità senza rinunciare al gusto retrò che caratterizza l'intera linea. Il bacino, di dimensione ampia e generosa, è incastonato in una minimale struttura in acciaio nella quale può essere appoggiata una mensola bassa oppure inserito un cassetto contenitore.

The evolution of the I Catini collection, this rectangular model seeks functionality without sacrificing the retro taste that characterizes the entire line. The large, generous dimension of the washbasin is embedded in a minimal steel structure in which a low shelf can be placed or a container box inserted.





lavabo \ washbasin: pomice
struttura \ framework: cemento
piano in legno \ wooden shelf: pomice
specchio tondo \ round mirror



lavabo \ washbasin: pomice
specchio tondo \ round mirror





lavabo \ washbasin: pomice
struttura \ framework: bronzo spazzolato
piano in legno \ wooden shelf: pomice
specchio round box \ round box mirror



lavabo \ washbasin: talco
struttura \ framework: nero matt
cassetto in legno \ wooden drawer: eucalipto
specchi argo \ argo mirror

Composizioni, materiali e finiture \ Compositions, materials and finishes

Catino Rettangolare con piano \ with shelf - cm 110 x 58,5 x h83

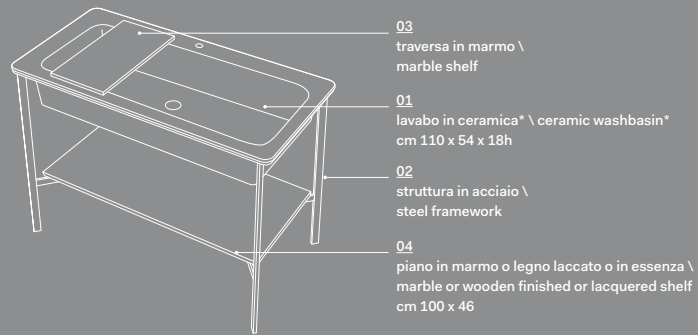

Catino Rettangolare con cassetto \ with drawer - cm 110 x 58,5 x h83

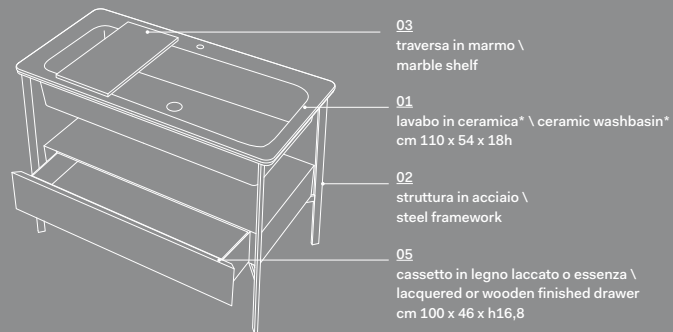

*lavabo monoforo predisposto 9 fori \ *washbasin with 1 hole prepared 9 holes

01 lavabo \ washbasin

materiale \ material:
ceramica \ ceramic

finiture \ finishes:
Le Terre di Cielo

- Talco
- Pomice
- Brina
- Basalto
- Lavagna
- Cemento
- Fango
- Cacao
- Arenaria
- Avena
- Lino
- Agave
- Muschio
- Polvere
- Cipria
- Canapa
- Bianco Lucido \
Gloss White

02 struttura \ framework

materiale \ material:
acciaio verniciato \
painted steel

verniciature \ coatings

- Nero Matt \ Matt Black
- Cemento
- Bronzo Spazzolato \
Brushed Bronze

03 traversa \ shelf

materiale \ material:
marmo \ marble

finiture \ finishes:

- Bianco Carrara Gioia
- Nero Marquina

04 piano \ shelf

materiale \ material:
legno laccato o in essenza,
marmo \ lacquer, wooden or
marble finish

laccature \ lacquers

- Talco
- Pomice
- Brina
- Arenaria
- Avena
- Cemento
- Basalto
- Muschio

essenze \ wooden finishes

- Rovere Naturale
- Rovere Sbiancato
- Rovere Grigio
- Rovere Nero
- Eucalipto

finiture \ finishes:
marmo \ marble

- Bianco Carrara Gioia
- Nero Marquina

05 cassetto \ drawer

materiale \ material:
legno laccato o in essenza
\ lacquer or wooden finish

laccature \ lacquers

- Talco
- Pomice
- Brina
- Arenaria
- Avena
- Cemento
- Basalto
- Muschio

essenze \ wooden finishes

- Rovere Naturale
- Rovere Sbiancato
- Rovere Grigio
- Rovere Nero
- Eucalipto

milano.

Un grande bacino e un comodo piano d'appoggio caratterizzano un mobile puro ed essenziale con piano in ceramica disponibile nelle 16 finiture della gamma Terre di Cielo o in bianco lucido con integrato un cassetto contenitore. La struttura in acciaio Nero Matt, Bronzo spazzolato o Cemento può essere completata da una cassetteria in essenza o laccata.

A large basin and a convenient top characterize a pure and essential furniture with a ceramic top available in 16 colours of Terre di Cielo range or glossy white and a storage drawer. The framework made of steel and available in Matt black, Brushed bronze or Cemento can be completed with a wooden or lacquered drawers.





lavabo \ washbasin: talco
struttura \ framework: nero matt
base con cassetto \ base with
drawer: rovere grigio
cassettiera \ drawers: rovere grigio
specchio tondo \ round mirror





lavabo \ washbasin: pomice
 struttura \ framework: nero matt
 base con cassetto \
 base with drawer: pomice
 cassettiera \ drawers: rovere naturale
 specchio round box \ round box mirror
 elemento porta sapone, dispenser,
 bicchiere e portasciugamani \
 soap holder element, dispenser, glass and
 towel rail





lavabo \ washbasin: talco
 struttura \ framework: nero matt
 base con cassetto \
 base with drawer: muschio
 cassettiera \ drawers: muschio
 specchio argo \ argo mirror
 elemento porta sapone, dispenser e
 bicchiere
 soap holder element, dispenser and glass
 wc e bidet sospesi shui comfort \
 shui comfort wall-hung wc and bidet: cemento
 piatto doccia in ceramica infinito \
 infinito ceramic shower tray: cemento



lavabo \ washbasin: basalto
 struttura \ framework: nero matt
 base con cassetto \
 base with drawer: basalto
 cassettiera \ drawers: rovere sbiancato
 specchio tondo \ round mirror



Materiali e finiture Materials and finishes

Milano: dimensioni \ sizes - cm 120 x 50 x h83

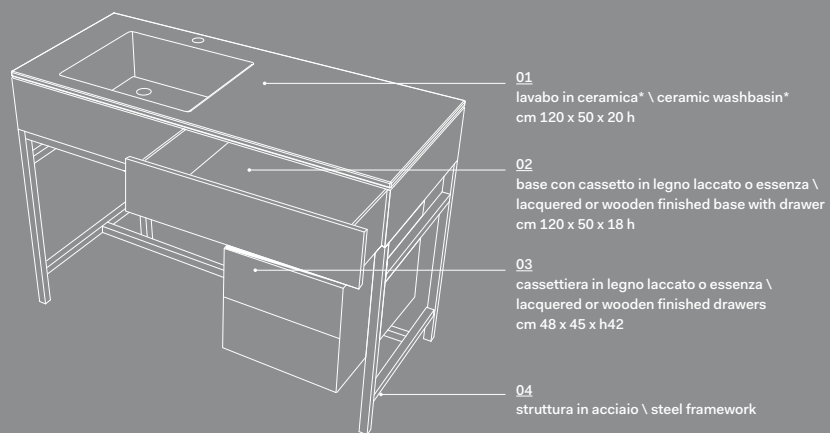

*lavabo monoforo predisposto 3 fori \ *washbasin with 1 hole prepared 3 holes

01 lavabo \ washbasin

materiale \ material:
ceramica \ ceramic

finiture \ finishes:
Le Terre di Cielo



● Bianco Lucido \
Gloss White

02 base con cassetto \ base with drawer

materiale \ material:
legno laccato o in essenza \
lacquer or wooden finish

laccature \ lacquers



essenze \ wooden finishes



03 cassettiera \ drawers

materiale \ material:
legno laccato o in essenza \
lacquer or wooden finish

laccature \ lacquers



essenze \ wooden finishes



04 struttura \ framework

materiale \ material:
acciaio verniciato \
painted steel

verniciature \ coatings



Infinite possibilità di personalizzazione \ Infinite customized solutions

narciso.

Innovativo lavabo in ceramica con grande bacino e comodo piano d'appoggio, con la possibilità di integrare un elemento "Make Up" dotato di specchio e portaoggetti. Un prodotto elegante, funzionale, versatile... un po' Narciso. Il lavabo è personalizzabile nelle 16 finiture della gamma Terre di Cielo. Il "Make Up" può essere laccato o in essenza.

Innovative washbasin in ceramic with a large basin and a convenient top, in which it is possible to integrate "make-up" element with mirror and beauty-case. A very elegant, functional and versatile product... like a real Narciso. The washbasin is available in 16 colours of Terre di Cielo range. The "make-up" element can be lacquered or in wooden finish.





lavabo \ washbasin: talco
 elemento "Make up" \
 "Make up" element: rovere nero
 struttura \ framework: nero matt
 cassettera \ drawers: rovere nero
 specchio argo \ argo mirror
 sacca portabiancheria \
 laundry bag: cuoio nero



lavabo \ washbasin: talco
 elemento "Make up" \
 "Make up" element: rovere nero
 struttura \ framework: nero matt
 cassetiera \ drawers: rovere nero
 specchio argo \ argo mirror
 sacca portabiancheria \ laundry
 bag: cuoio nero



lavabo \ washbasin: talco
elemento "Make up" \
"Make up" element: rovere nero
struttura \ framework: nero matt
cassettera \ drawers rovere nero

lavabo \ washbasin: talco
 elemento "Make up" \
 "Make up" element: rovere nero



lavabo \ washbasin: talco
 elemento "Make up" \
 "Make up" element: eucalipto
 struttura \ framework: nero matt
 cassettiera \ drawers: arenaria
 specchio argo \ argo mirror
 sacca portabiancheria \
 laundry bag: cuoio naturale



Materiali e finiture Materials and finishes

Narciso: dimensioni \ sizes - cm 130 x 50 x 83h

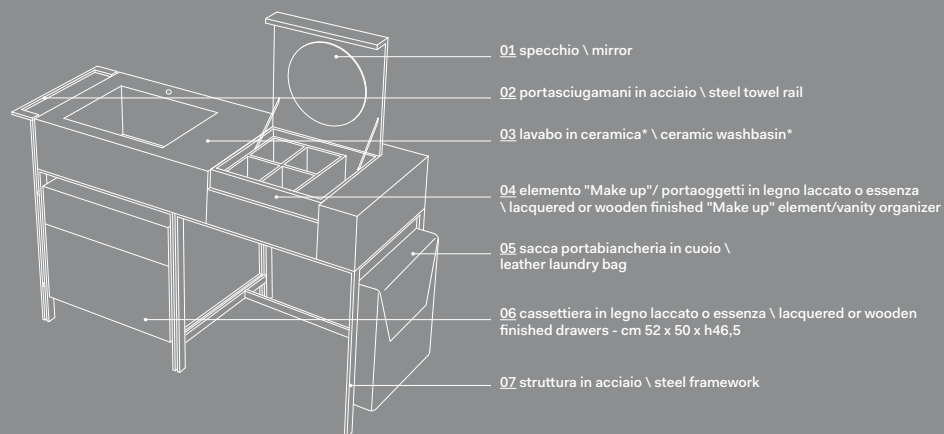

*lavabo monoforo predisposto 3 fori \ *washbasin with 1 hole prepared 3 holes

03 lavabo \ washbasin

materiale \ material:
ceramica \ ceramic

finiture \ finishes:
Le Terre di Cielo

- Talco
- Pomice
- Brina
- Basalto
- Lavagna
- Cemento
- Fango
- Cacao
- Arenaria
- Avena
- Lino
- Agave
- Muschio
- Polvere
- Cipria
- Canapa

04 / 06 elemento "Make up" e cassettera \ "Make up" element and drawers

materiale \ material:
legno laccato o in essenza \
lacquer or wooden finish

laccature \ lacquers

- Talco
- Pomice
- Brina
- Arenaria
- Avena
- Cemento
- Basalto
- Muschio

essenze \ wooden finishes

- Rovere Naturale
- Rovere Sbiancato
- Rovere Grigio
- Rovere Nero
- Eucalipto

02 / 07 struttura e portasciugamani \ framework and towel rail

materiale \ material:
acciaio \ steel

verniciature \ coatings

- Nero Matt \ Matt Black
- Cemento
- Bronzo Spazzolato \
Brushed Bronze

05 sacca \ laundry bag

materiale \ material:
cuoio naturale \ real leather

- Nero \ Black
- Cuoio naturale \ leather

Infinite possibilità di personalizzazione \ Infinite customized solutions

narciso mini.

Le dimensioni ridotte di questo lavabo lo rendono adatto anche agli ambienti piccoli senza rinunciare alla praticità, garantita dalla presenza di un cassetto basso o una cassettera, un vano a giorno e un porta asciugamani. Il sapiente gioco 'pieno-vuoto' dei volumi e l'utilizzo di materiali diversi ma pienamente integrati - ceramica per il bacino, legno per le cassettiere e acciaio verniciato per la struttura - conferiscono a Narciso Mini classe ed eleganza.

The small dimensions of this washbasin make it suitable for small environments without having to sacrifice practicality, which is guaranteed by the presence of drawers, a compartment and a towel rail. The clever "full-empty" game of space combined with the use of different but completely integrated materials - ceramic for the basin, wood for the drawers and painted steel for the structure - bestow class and elegance to Narciso Mini.





lavabo \ washbasin: pomice
struttura e portasciugamani \
framework and towel rail: nero matt
box porta oggetti in metallo \
metal storage box: nero matt
cassettiera \ drawers: cemento
specchio polifemo \ polifemo mirror



lavabo \ washbasin: brina
struttura e portasciugamani \
framework and towel rail: nero matt
cassetto \ drawer: eucalipto
specchi argo e pluto \
argo and pluto mirror



lavabo \ washbasin: muschio
struttura e portasciugamani \
framework and towel rail: nero matt
box porta oggetti in metallo \
metal storage box: nero matt
cassettiera \ drawers: muschio
specchio polifemo \ polifemo mirror

Composizioni, materiali e finiture \ Compositions, materials and finishes

Narciso Mini: dimensioni \ sizes - cm 76 x 50 x 83h

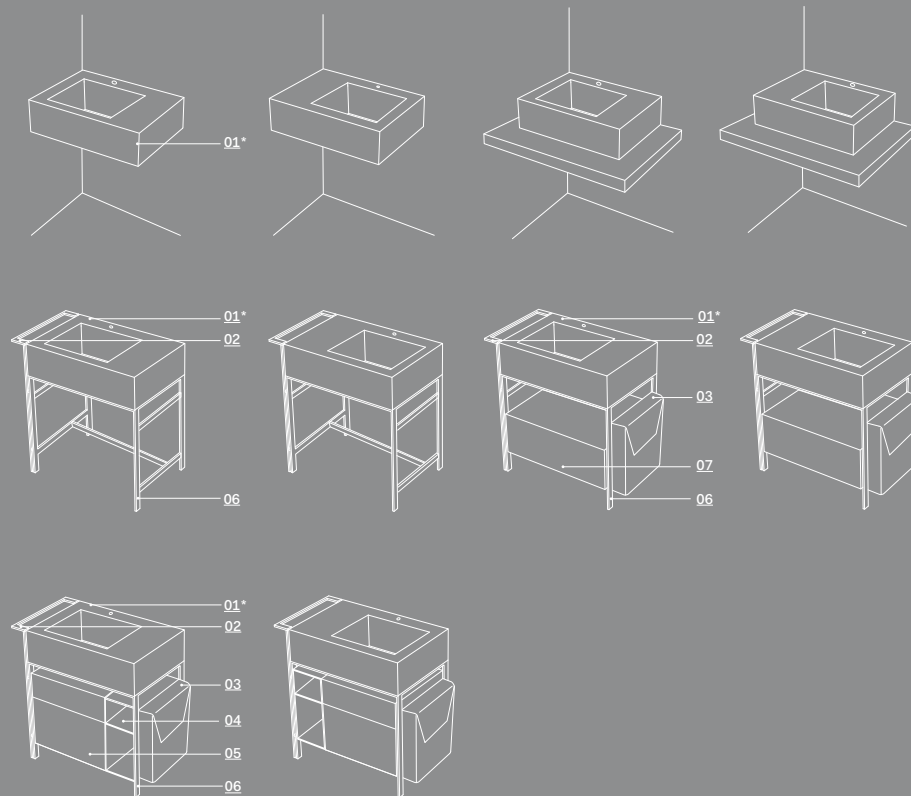

*lavabo monoforo predisposto 3 fori \ *washbasin with 1 hole prepared 3 holes

01 lavabo \ washbasin

materiale \ material:
ceramica \ ceramic

finiture \ finishes:
Le Terre di Cielo

- Talco
- Pomice
- Brina
- Basalto
- Lavagna
- Cemento
- Fango
- Cacao
- Arenaria
- Avena
- Lino
- Agave
- Muschio
- Polvere
- Cipria
- Canapa
- Bianco Lucido \ Gloss White

07/05 cassetto e cassettiera \ drawers

materiale \ material:
legno laccato o in essenza
\ lacquer or wooden finish

laccature \ lacquers

- Talco
- Pomice
- Brina
- Arenaria
- Avena
- Cemento
- Basalto
- Muschio

essenze \ wooden finishes

- Rovere Naturale
- Rovere Sbiancato
- Rovere Grigio
- Rovere Nero
- Eucalipto

06/02 struttura e portasciugamani \ framework and towel rail

materiale \ material:
acciaio \ steel

verniciature \ coatings

- Nero Matt \ Matt Black
- Cemento
- Bronzo Spazzolato \ Brushed Bronze

04 box portaoggetti \ storage box

materiale \ material:
metallo \ metal

verniciature \ coatings

- Nero Matt \ Matt Black
- Cemento
- Bronzo Spazzolato \ Brushed Bronze

03 sacca \ laundry bag

materiale \ material:
cuoio naturale \ real leather

- Nero \ Black
- Cuoio naturale \ leather

Infinite possibilità di personalizzazione \ Infinite customized solutions

narciso doppio.

Pensato per una sala da bagno elegante e minimale, questo lavabo risponde perfettamente alle esigenze di comfort grazie al doppio bacino, ricavato da un unico blocco in ceramica. L'essenzialità delle linee è accentuata dalla struttura in acciaio e dai volumi contenitori, che dialogano con i lavabi dando vita a un prodotto raffinato e puro dalla "polifunzionalità allargata".

Designed for an elegant and minimalist bathroom, this washbasin perfectly meets the high demands of comfort, thanks to the double basin carved from a single ceramic block. The simplicity of the lines is accentuated by the steel structure and the capacity of the drawers, that interact with the washbasins, creating a refined and pure product from "extended multifunctionality".





lavabo \ washbasin: cemento
struttura e portasciugamani \
framework and
towel rails: nero matt
cassettiere \ drawers: eucalipto
specchio tondo \ round mirror



lavabo \ washbasin: cemento
struttura e portasciugamani \ framework
and towel rails: nero matt
cassettiere \ drawers: eucalipto
specchio tondo \ round mirror



Composizioni, materiali e finiture \ Compositions, materials and finishes

Narciso Doppio: dimensioni \ sizes - cm 113 x 50 x h83

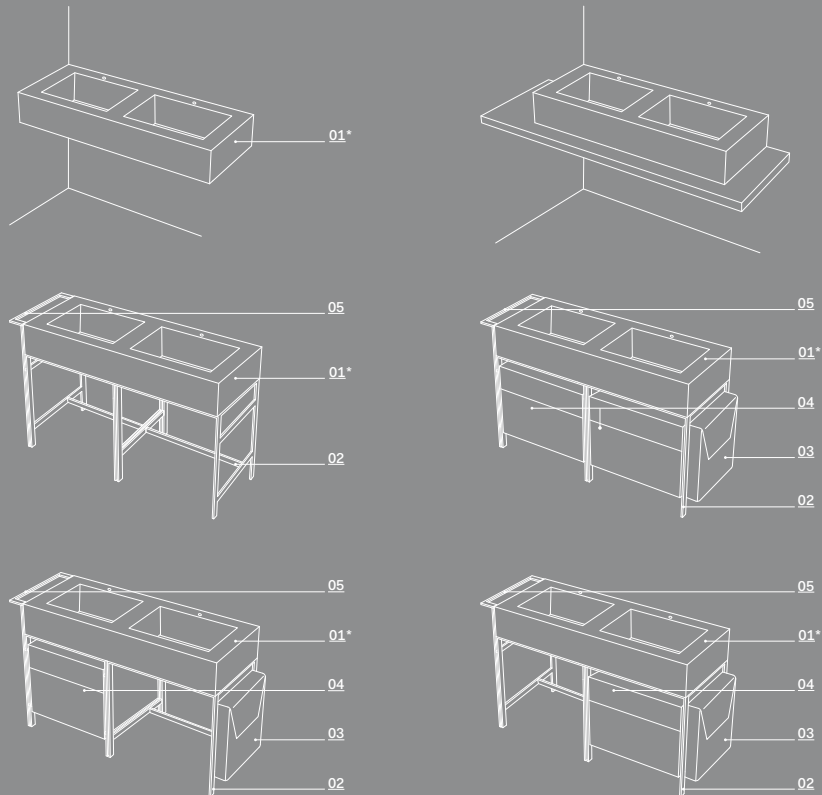

*lavabo con 2 fori predisposto 6 fori \ *washbasin with 2 holes prepared 6 holes

01 lavabo \ washbasin

materiale \ material:
ceramica \ ceramic

finiture \ finishes:
Le Terre di Cielo



02/05 struttura e portasciugamani \ framework and towel rails

materiale \ material:
acciaio verniciato \
painted steel

verniciature \ coatings



04 cassettiere \ drawers

materiale \ material:
legno laccato o in essenza
\ lacquer or wooden finish

laccature \ lacquers



essenze \ wooden finishes



03 sacca \ laundry bag

materiale \ material:
cuoio naturale \ real leather

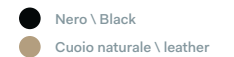

Infinite possibilità di personalizzazione \ Infinite customized solutions

siwa.

Il fascino del lungo viaggio, la libertà del movimento, il relax della sosta...
Dalla costante ricerca di oggetti evocativi ma dalle linee contemporanee nasce Siwa: il lavabo 'nomade', dal gusto coloniale, che poggia su cavalletti ed esalta il piacere della pausa di bellezza nella sala da bagno, come dopo un lungo vagare.

The charm of a long journey, the freedom of movement, the relaxation of a break...
From the consistent search for evocative objects but with contemporary lines, Siwa is born: a "nomadic" washbasin with a colonial taste that rests on trestles and enhances the infinite pleasure of a relaxing beauty break in the bathroom, as after a long journey..



lavabo \ washbasin: muschio
cassetto in legno \ wooden drawer:
rovere sbiancato
struttura in legno \ wooden
framework: rovere sbiancato
specchiera rettangolare con
accessori \ rectangular mirror with
accessories: rovere sbiancato
sacca porta oggetti \
storage bag: cuoio naturale





lavabo \ washbasin: talco
 vassoio in legno \ wooden tray: rovere nero
 struttura in legno \ wooden framework:
 rovere nero
 specchiera tonda con accessori \
 round mirror with accessories: rovere nero
 sacca porta oggetti \
 storage bag: cuoio nero

Materiali e finiture Materials and finishes

Siwa con vassoio o con cassetto \ with tray or drawer - cm 92 x 51 x h89

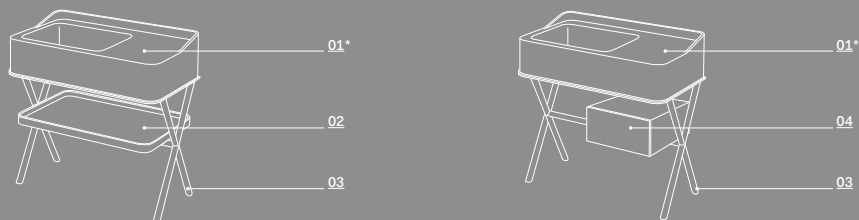

Composizione specchiera tonda e sacca portaoggetti \ Round mirror composition and storage bag

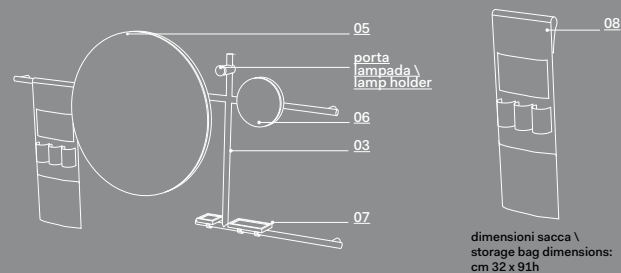

Composizione specchiera rettangolare e sacca portaoggetti \ Rectangular mirror composition and storage bag

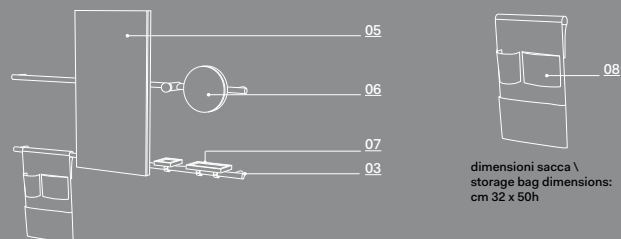

*lavabo monoforo predisposto 3 fori \ *washbasin with 1 hole prepared 3 holes

Sacca portaoggetti da muro \ Wall-hung leather storage bag

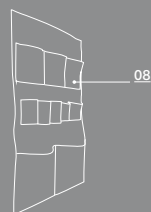

01 lavabo \ washbasin
cm 90 x 50 x 20 h

materiale \ material:
ceramica \ ceramic

finiture \ finishes:
Le Terre di Cielo



● Bianco Lucido \ Gloss White

05 specchi tondo e rettangolare \ mirrors: round and rectangular
090
cm 45 x 110 h

materiale \ material:
legno e vetro \ wood and glass

laccature legno \ wooden lacquers



02 vassoio \ tray
cm 72 x 42 x 3,5 h

materiale \ material:
legno laccato o massello in
essenza \ lacquered wood or
solid wood

laccature legno \ wooden
lacquers

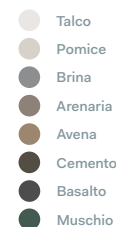

legno Massello essenze
\ solid wood finishes

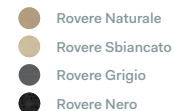

06 specchio ingranditore \ magnifying mirror
025

materiale \ material:
metallo e vetro \ metal and glass

verniciature metallo \ metal coatings

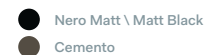

03 struttura lavabo e barra
specchio \ washbasin
framework and mirror bar

materiale \ materials:
legno massello o acciaio
verniciato \
solid wood or coated steel

legno massello \ solid
wood

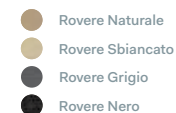

verniciature metallo \ metal coatings



07 mensole \ shelves
cm 10 x 9 x 1,5
cm 20 x 9 x 1,5

materiale \ material:
LivingTec



04 cassetto \ drawer
cm 35 x 38 x 18 h

materiale \ material:
legno laccato o in essenza
\ lacquered wood or wooden
finish

laccature legno \ wooden
lacquers

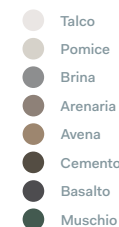

essenze \ wooden
finishes

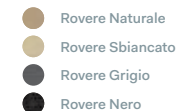

08 sacche portaoggetti \ storage bags
cm 32 x 91 h
cm 32 x 50 h
cm 64 x 90 h

materiale \ material:
cuoio naturale \ real leather

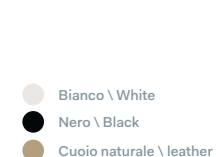

Infinite possibilità di personalizzazione \ Endless possibilities for customisation

kyros.

La proposta aggraziata e minimal in grado di raccontare la creatività contemporanea. La purezza delle forme e le geometrie nette sono esaltate da un comodo porta asciugamani in legno, pratico ed elegante. La finitura in legno è ripresa anche nel contenitore sottostante contraddistinto dall'apertura asimmetrica dell'anta.

The graceful and minimal proposal able to portray the contemporary creativity. The purity of the forms and the clear geometries are enhanced by a convenient wooden towel rail, practical and elegant. The wood finish is also reflected in the underlying container distinguished by the asymmetric opening of the door





lavabo \ washbasin: basalto
 struttura \ framework: nero matt
 cassetto \ drawer: basalto
 portasciugamani in legno \ wooden
 towel rail: rovere nero



lavabo \ washbasin: muschio
 struttura \ framework: nero matt
 cassetto \ drawer: muschio
 portasciugamani in legno \ wooden
 towel rail: rovere nero
 specchio eos \ eos mirror



lavabo \ washbasin: talco
 struttura \ framework: nero matt
 cassetto \ drawer: basalto
 portasciugamani in legno \ wooden
 towel rail: rovere nero
 specchio round \ round mirror
 porta sapone \ soap holder

Materiali e finiture Materials and finishes

Kyros: dimensioni \ sizes - 78,5 x 50 x h 85

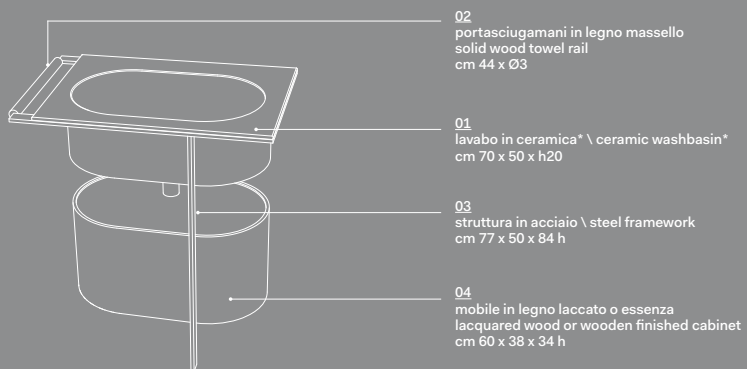

*lavabo monoforo predisposto 3 fori \ *washbasin with 1 hole prepared 3 holes

01 lavabo \ washbasin

materiale \ material:
ceramica \ ceramic

finiture \ finishes:
Le Terre di Cielo



02 portasciugamani \ towel rail

materiale \ material:
legno massello \ solid wood

essenze \ wooden finishes

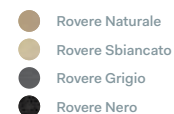

03 struttura \ framework

materiale \ material:
acciaio verniciato \ coated steel

verniciature \ coatings



04 mobile \ cabinet

materiale \ material:
legno laccato o in essenza
\ lacquered wood or wooden finish

laccature \ lacquers

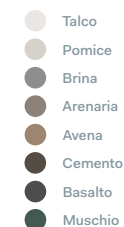

Essenze \ wooden finishes



N.B.
il mobile nella finitura Eucalipto
va in abbinamento solo con il
portasciugamani Rovere Nero e
con la struttura in metallo Nero
Matt / The Eucalipto finish cabinet
can only be combined with the
Rovere Nero towale rail and the
Nero matt framework

Infinite possibilità di personalizzazione \ Endless possibilities for customisation

delfo.

Caratterizzato da un'eleganza che ama la combinazione di linee rigorose e simmetriche e forme morbide, Delfo si esprime con la potenza dei materiali, in un gioco di abbinamenti tra ceramica e legno, che dà vita a diverse interpretazioni di un unico modello, unite dalla stessa visione estetica e dalla stessa capacità di rileggere in chiave contemporanea il materiale ceramico.

Characterised by an elegance that loves the combination of rigorous and symmetrical lines and soft shapes, Delfo expresses itself with the power of the materials, in a game of combinations between ceramics and wood, which gives life to different interpretations of a single model, united by the same aesthetic vision and the same ability to re-read the ceramic material in a contemporary way.





lavabo tino \ tino washbasin: talco
 top ovale in ceramica \ ceramic oval top: talco
 mobile \ cabinet: rovere grigio



lavabo tino \ tino washbasin: talco
 top ovale in ceramica \ ceramic oval top: talco
 mobile \ cabinet: eucalipto
 specchio eos-c \ eos-c mirror

Materiali e finiture Materials and finishes

Delfo: dimensioni \ sizes - cm 113 x 52

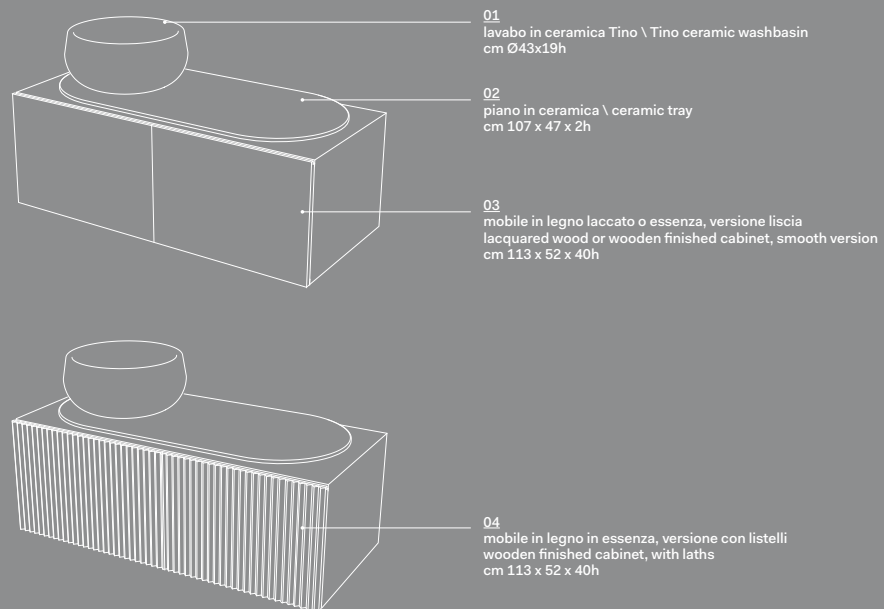

01 lavabo \ washbasin

materiale \ material:
ceramica \ ceramic

finiture \ finishes:
Le Terre di Cielo



02 piano \ top

materiale \ material:
ceramica \ ceramic

finiture \ finishes:
Le Terre di Cielo



03 mobile versione liscia \ cabinet, smooth version

materiale \ material:
legno laccato o in essenza
\ lacquered wood or wooden
finish

laccature \ lacquers



Essenze \ wooden finishes



04 mobile versione listelli \ cabinet with laths

materiale \ material:
legno in essenza \ wooden
finish

Essenze \ wooden finishes

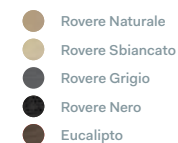

sella.

La soluzione fa della leggerezza e della funzionalità la sua forza e gioca sulle geometrie: quella tonda del profondo lavabo in ceramica e quella rettangolare dell'elemento porta oggetti in LivingTec, armoniosamente integrati tra loro. Ad enfatizzare lo spirito contemporaneo di Sella è Otto Tondo, il pouf contenitore in LivingTec, da utilizzare come seduta, elemento contenitore o tavolino, che riprende la forma circolare del lavabo e arricchisce l'ambiente, preservando l'armonia del progetto.

The solution makes lightness and functionality its strength and plays on the geometries: the roundness of the deep ceramic washbasin and the rectangular form of the object holder in LivingTec, harmoniously integrated with each other. To emphasize the contemporary spirit of Sella is Otto Tondo, the container pouf in LivingTec, use as a seat, a storage element or a table, Otto takes the circular shape of the sink and enriches the environment, preserving the harmony of the project.





lavabo \ washbasin: talco
 elemento portaoggetti in livingtec \
 livingtec storage unit: bianco matt
 pouf otto
 specchio pan \ pan mirror

Materiali e finiture Materials and finishes

Sella: dimensioni \ sizes - 110 x 48 x h20

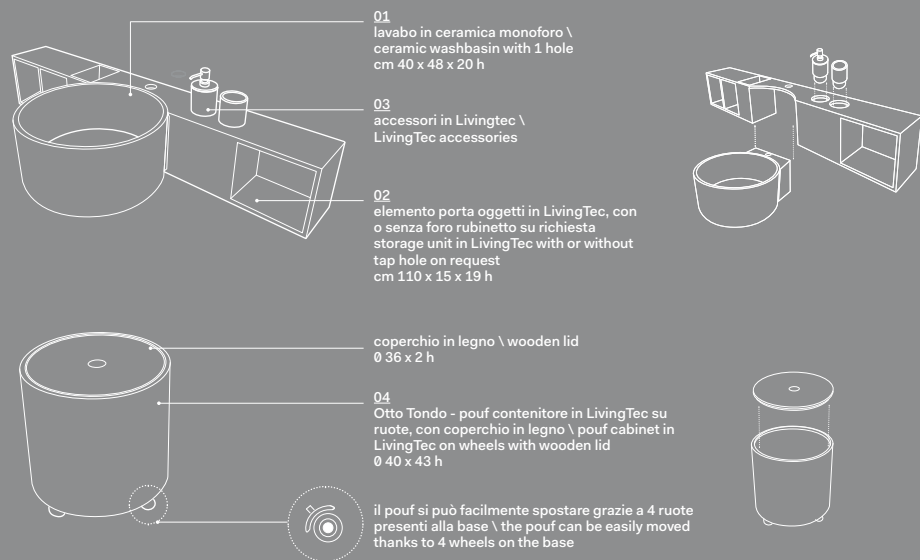

Predisposizione fori rubinetteria \ predisposition of tap holes



lavabo monoforo, senza foro su richiesta
washbasin with one hole, without tap hole on request

01 lavabo \ washbasin

materiale \ material:
ceramica \ ceramic

finiture \ finishes:
Le Terre di Cielo

- Talco
- Pomice
- Brina
- Basalto
- Lavagna
- Cemento
- Fango
- Cacao
- Arenaria
- Avena
- Lino
- Agave
- Muschio
- Polvere
- Cipria
- Canapa
-
- Bianco Lucido \ Gloss White

02 elemento portaoggetti \ storage unit

materiale \ material:
LivingTec

LivingTec

- Bianco Matt \ Matt White
- Brina
- Arenaria

03 accessori \ accessories

materiale \ material:
LivingTec

● Bianco Matt \ Matt White

parti in metallo \ metal parts
verniciature \ coatings

- Nero Matt \ Matt Black
- Cemento
- Cromo
- Bronzo Spazzolato \ Brushed Bronze

04 Otto tondo pouf tondo \ round pouf

materiale \ material:
LivingTec

pouf
LivingTec

- Bianco Matt
- Brina
- Arenaria

coperchio \ lid laccature \ lacquers

- Talco
- Brina
- Arenaria

coperchio \ lid essenze legno \ wooden finishes

- Rovere Naturale
- Rovere Sbiancato
- Rovere Grigio
- Rovere Nero

Infinite possibilità di personalizzazione \ Endless possibilities for customisation

elle.

Il lavabo sospeso ultra light, elegante e camaleontico. Design lineare e forma squadrata, impreziosita dall'iconica morbidezza della ceramica: in principio c'è sempre la materia, che in questa proposta intesse un inedito dialogo tra innovazione e tradizione artigianale.

Elle Tonda, più rigorosa e contemporanea e Elle Ovale, più classica, sono due universi contigui ognuno con il proprio codice estetico.

The ultra light suspended washbasin, elegant and chameleonic. Linear design and square shape, embellished by the iconic softness of ceramics: in the beginning there is always the material, which in this proposal weaves an unprecedented dialogue between innovation and craft tradition. Elle Tonda, more rigorous and contemporary and Elle Ovale, more classical, are two contiguous universes each with their own aesthetic code.





elle tonda
 lavabi \ washbasins: brina-cemento
 alzatine in ceramica \ ceramic
 backslashes: brina-cemento
 struttura \ framework: nero matt
 specchio pluto \ pluto mirror
 pouf otto



elle tonda
 lavabo \ washbasin: brina
 alzatina in ceramica \ ceramic
 backslash: brina
 struttura \ framework: nero matt
 pouf otto tondo \ round



elle ovale
 lavabo \ washbasin: canapa
 alzatina in ceramica \ ceramic
 backsplash: canapa
 struttura \ framework: nero matt
 specchio pluto \ pluto mirror
 pouf otto



elle ovale
 lavabo \ washbasin: basalto
 alzatina in ceramica \ ceramic
 backsplash: basalto
 struttura \ framework: nero matt
 porta sapone e portasciugamani \
 soap holder and towel rail



elle ovale
 lavabo \ washbasin: lavagna
 alzatina in ceramica \ ceramic
 backplash: lavagna
 struttura \ framework: cemento
 porta sapone e portasciugamani \
 soap holder and towel rail



elle ovale
 lavabo \ washbasin: pomice
 alzatina in ceramica \ ceramic
 backplash: pomice
 struttura \ framework: bronzo spazzolato
 porta sapone \ soap holder
 vasca dafne \ dafne bathtub
 pouf otto ovale \ oval



elle ovale
 lavabo \ washbasin: pomice
 alzatina in ceramica \ ceramic
 backplash: pomice
 struttura \ framework:
 bronzo spazzolato
 pouf otto ovale \ oval



elle tonda
 lavabo \ washbasin: talco
 alzatina in ceramica \ ceramic
 backplash: talco
 struttura \ framework: nero matt
 porta sapone e bicchiere \
 soap and cup holder
 pouf otto tondo \ round

Materiali e finiture Materials and finishes

Elle Tonda

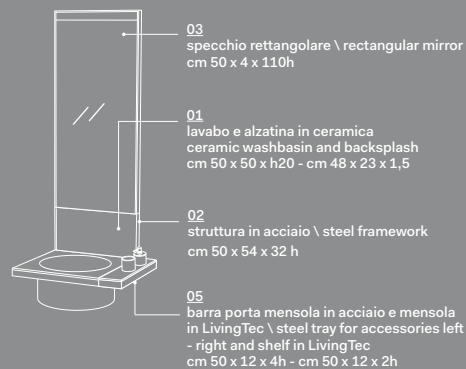

Elle Ovale

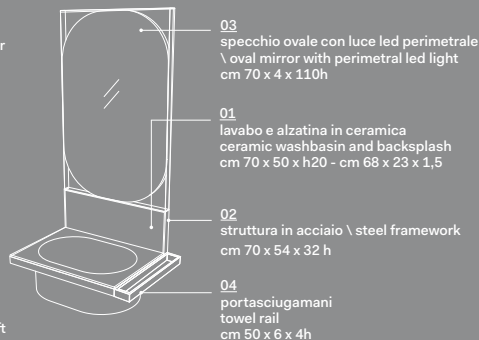

Pouf tondo \ round stool

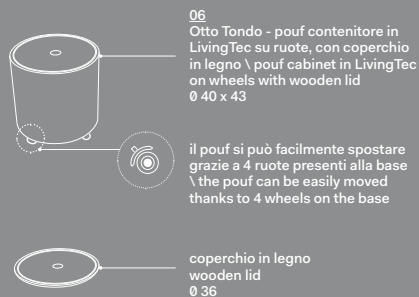

Pouf ovale \ oval stool

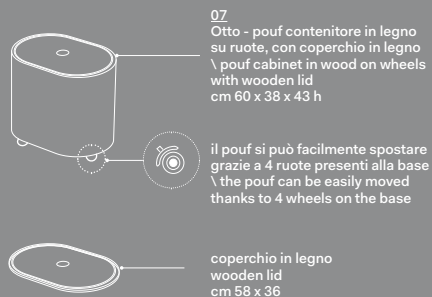

Predisposizione fori rubinetteria \ predisposition of tap holes



lavabo \ washbasin:
monoforo: 3 posizioni
1 hole: 3 positions



alzatina \ backsplash:
N.B. i fori rubinetto dovranno essere
eseguiti a cura dell'installatore
the tap holes must be carried out by
the installer

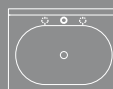

lavabo monoforo predisposto
3 fori, senza foro su richiesta
washbasin with one hole
prepared 3 holes, without tap
hole on request



alzatina \ backsplash:
N.B. i fori rubinetto dovranno essere
eseguiti a cura dell'installatore
the tap holes must be carried out by
the installer

01 lavabo e alzatina \ washbasin and backsplash

materiale \ material:
ceramica \ ceramic

finiture \ finishes: Le Terre di Cielo

- Talco
- Pomice
- Brina
- Basalto
- Lavagna
- Cemento
- Fango
- Cacao
- Arenaria
- Avena
- Lino
- Agave
- Muschio
- Polvere
- Cipria
- Canapa

- Bianco Lucido \
Gloss White

02 \ 04 struttura e portasciugamani \ framework and towel rail

materiale \ material:
acciaio verniciato \
coated steel

verniciature \ coatings

- Nero Matt \ Matt Black
- Cemento
- Bronzo Spazzolato \
Brushed Bronze

03 specchi rettangolare e ovale \ rectangular and oval mirrors

materiale \ material:
acciaio verniciato \
coated steel

verniciature scocca \ shell coatings

- Nero Matt \ Matt Black
- Cemento
- Bronzo Spazzolato \
Brushed Bronze

06 Otto Tondo pouf tondo \ round pouf

materiale \ material:
LivingTec

pouf LivingTec

- Bianco Matt \ Matt White
- Brina
- Arenaria

coperchio \ lid laccature \ lacquers

- Talco
- Brina
- Arenaria

coperchio \ lid essenze legno \ wooden finishes

- Rovere Naturale
- Rovere Sbiancato
- Rovere Grigio
- Rovere Nero

07 Otto Ovale pouf ovale \ oval pouf

materiale \ material:
legno laccato o essenza \
lacquered wood or wooden
finish

pouf + coperchio \ pouf + lid laccature \ lacquers

- Talco
- Pomice
- Brina
- Arenaria
- Avena
- Cemento
- Basalto
- Muschio

pouf + coperchio \ pouf + lid essenze legno \ wooden finishes

- Rovere Naturale
- Rovere Sbiancato
- Rovere Grigio
- Rovere Nero

05 barra e mensola \ tray and shelf

materiale \ material:
barra in acciaio verniciato e mensola in LivingTec \ tray in
coated steel and shelf in LivingTec

verniciature barra \ tray coatings

- Nero Matt \ Matt Black
- Cemento
- Bronzo Spazzolato \
Brushed Bronze

mensola \ shelf LivingTec

- Bianco Matt \ Matt White
- Brina
- Arenaria

Infinita possibilità di personalizzazione \ Endless possibilities for customisation

Elle Tonda

elementi che compongono Elle Tonda \ Elle Tonda components

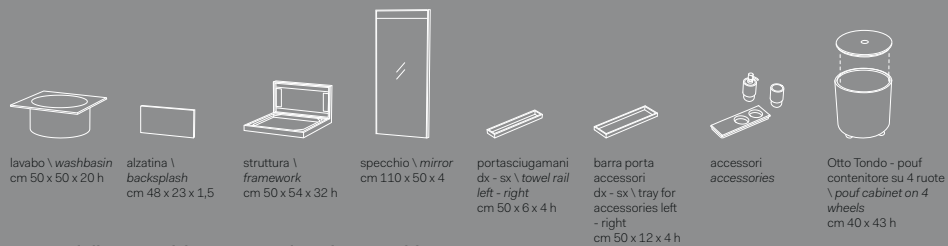

esempi di composizione \ examples of compositions

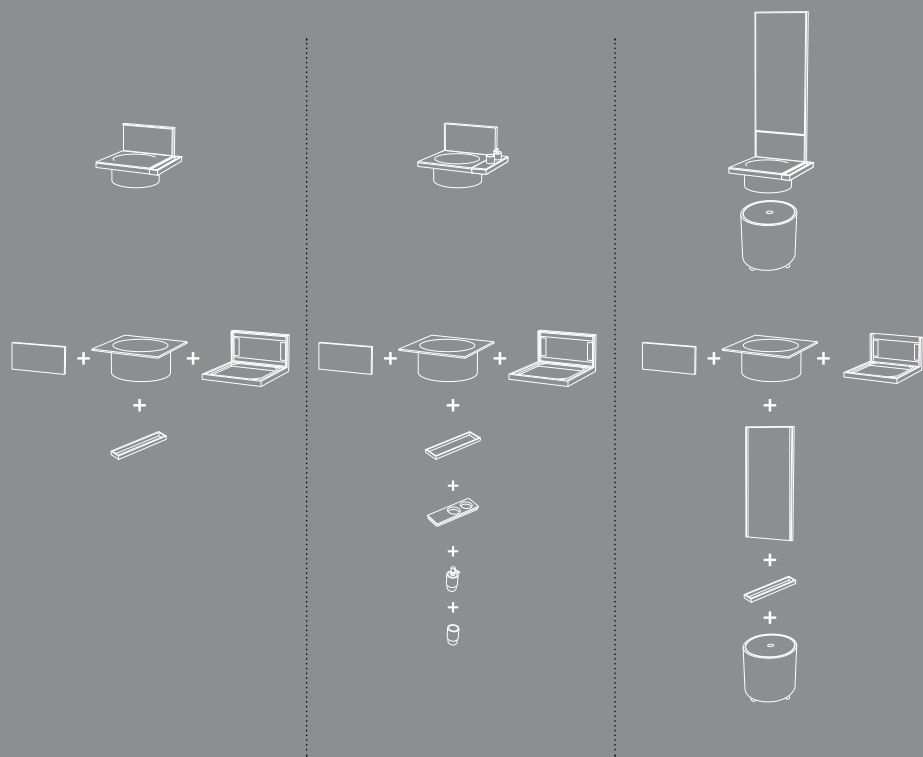

Elle Ovale

elementi che compongono Elle Ovale \ Elle Ovale components



esempi di composizione \ examples of compositions

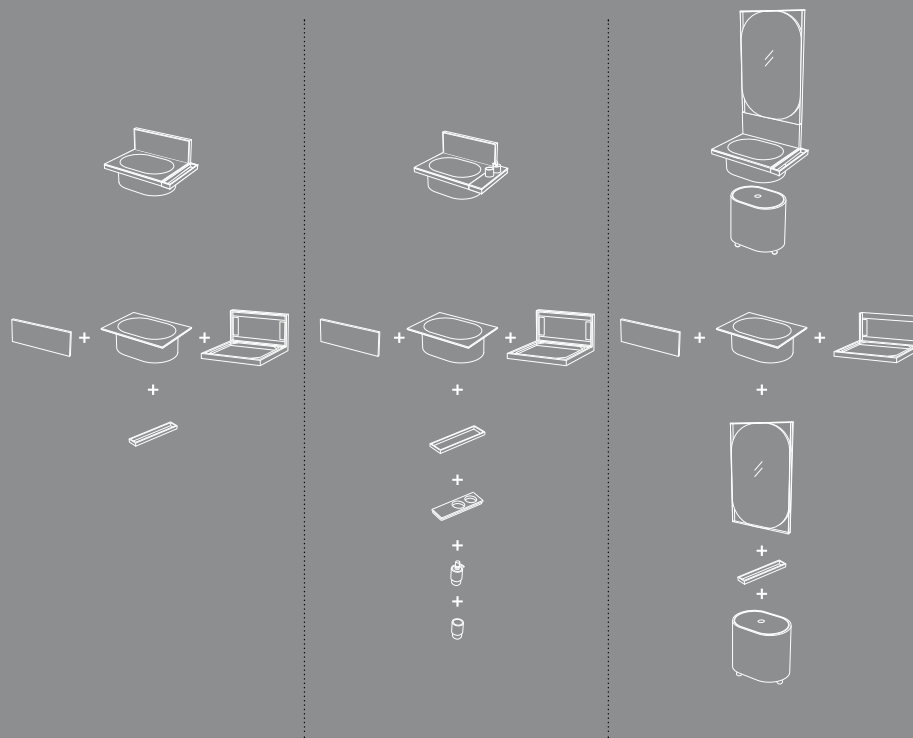

plinio.

Capace di adattarsi a gusti ed esigenze diverse, Plinio è l'esempio di un perfetto equilibrio di proporzioni rigorose in armonia con il concetto, sempre vincente, di funzionalità. L'ampio lavabo con pratico piano d'appoggio, proposto in 3 formati nelle 16 esclusive nuance delle Terre di Cielo, è incastonato in una raffinata struttura extra slim, dal design leggero e al contempo rigoroso, disponibile in metallo e in pregiato legno Massello.

Capable of adapting to different tastes and needs, Plinio is an example of a perfect balance of rigorous proportions in harmony with the always winning concept of functionality. The large washbasin with practical countertop, offered in three dimensions and in the 16 exclusive nuances of the Terre di Cielo colour palette, is set in a refined extra-slim structure, with a light and at the same time rigorous design, available in metal and in precious solid wood.





lavabo \ washbasin: pomice
struttura \ framework: rovere nero
cassetto \ drawer: rovere nero
ceste in cuoio \ baskets in leather: bianco \ white
specchio pan \ pan mirror

Enfatizzano il disegno minimale e iper grafico di Plinio il piano o il largo cassetto in legno inserito alla base della struttura. Dettagli preziosi e sofisticati a corredo del progetto, come i raffinati cesti di cuoio naturale, rubati al mondo del fashion, confermano la capacità dell'azienda di dare vita a manufatti customizzati in grado di decorare gli ambienti, coniugando sempre funzionalità e stile.

Emphasizing the minimal and hyper-graphic design of Plinio, the top or the wide wooden drawer inserted at the base of the structure. Precious and sophisticated details accompanying the project, such as the refined baskets of natural leather, stolen from the fashion world, confirm the capacity of the company to create customized items able to decorate the environment, always combining functionality and style.

lavabo \ washbasin: pomice
 struttura \ framework: rovere nero
 cassetto \ drawer: rovere nero
 ceste in cuoio \ baskets in leather: bianco \ white
 specchio pan \ pan mirror

Materiali e finiture Materials and finishes

Plinio con cassetto / with drawer

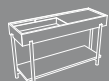

cm 140 x 46 x h83



cm 115 x 46 x h83



cm 85 x 46 x h83

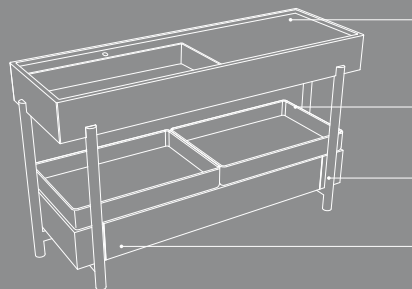

01
lavabo in ceramica* \
ceramic washbasin*

05
ceste in cuoio \
leather baskets

02
struttura in acciaio o legno massello \
steel or solid wood

03
cassetto in legno laccato o essenza \
lacquered wood or wooden finished drawer

Plinio con piano / with shelf

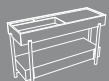

cm 140 x 46 x h83



cm 115 x 46 x h83



cm 85 x 46 x h83

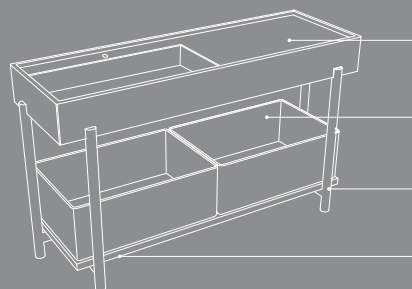

01
lavabo in ceramica* \
ceramic washbasin*

05
ceste in cuoio \
leather baskets

02
struttura in acciaio o legno \
steel or wooden framework

04
piano in legno laccato o essenza \
lacquered wood or wooden finished shelf

*lavabo monoforo predisposto 3 fori \ *washbasin with 1 hole prepared 3 holes

01 lavabo \ washbasin

materiale \ material:
ceramica \ ceramic

02 struttura \ framework

materiale \ material:
metallo o legno massello \
metal or solid wood

03 cassetto \ drawer

materiale \ material:
legno laccato o in essenza
\ lacquered wood or wooden
finish

04 piano \ shelf

materiale \ material:
legno laccato o in essenza
\ lacquered wood or wooden
finish

finiture \ finishes:
Le Terre di Cielo

- Talco
- Pomice
- Brina
- Basalto
- Lavagna
- Cemento
- Fango
- Cacao
- Arenaria
- Avena
- Lino
- Agave
- Muschio
- Polvere
- Cipria
- Canapa

● Bianco Lucido \
Gloss White

metallo \ metal
verniciature \ coatings

- Nero Matt \ Matt Black
- Cemento

legno massello \ solid
wood

- Rovere Naturale
- Rovere Sbiancato
- Rovere Grigio
- Rovere Nero

laccature \ lacquers

- Talco
- Pomice
- Brina
- Arenaria
- Avena
- Cemento
- Basalto
- Muschio

essenze \ wooden finishes

- Rovere Naturale
- Rovere Sbiancato
- Rovere Grigio
- Rovere Nero
- Eucalipto

N.B.
la finitura Eucalipto va in
abbinamento solo con la
struttura in metallo Nero Matt
/ the Eucalipto finish can only be
combined with the Nero Matt metal
framework

laccature \ lacquers

- Talco
- Pomice
- Brina
- Arenaria
- Avena
- Cemento
- Basalto
- Muschio

essenze \ wooden finishes

- Rovere Naturale
- Rovere Sbiancato
- Rovere Grigio
- Rovere Nero
- Eucalipto

N.B.
la finitura Eucalipto va in
abbinamento solo con la
struttura in metallo Nero Matt
/ the Eucalipto finish can only be
combined with the Nero Matt metal
framework

05 ceste \ baskets

materiale \ material:
cuoio naturale \ real leather

- Bianco \ White
- Nero \ Black
- Cuoio naturale \ leather

Infinite possibilità di personalizzazione \ Endless possibilities for customisation

modulo.

L'inedito sistema d'arredobagno flessibile e modulare, che vede al centro del progetto il lavabo Narciso, al quale si affiancano o sovrappongono a piacere i contenitori nelle diverse finiture. Prerogativa di Modulo è l'estrema libertà compositiva che nasce dalla combinazione dei diversi moduli della collezione con cassetti di varie dimensioni, unita alla possibilità di abbinare colori e finiture differenti, dando così vita ad un vasto range di configurazioni.

The new flexible and modular bathroom furnishing system, with the Narciso washbasin at the centre of the project, to which cabinets in different finishes can be placed side by side or overlapped at will. Modulo's prerogative is the extreme freedom of composition that comes from the combination of the different modules of the collection with drawers of various sizes, combined with the possibility of combining different colours and finishes, thus giving life to a wide range of configurations.





modulo
lavabo narciso \ narciso washbasin: avena
cassetto 54 \ 54 drawer: eucalipto



modulo
lavabo narciso \ narciso washbasin: talco
cassetto 54 \ 54 drawer: eucalipto
cassetti 76 e 113 \ 76 and 113 drawers: talco
specchio \ mirror round box

Materiali e finiture Materials and finishes

Modulo con lavabo Narciso Mini, cassettono sospeso e/o cassetto laterale \ Modulo with Narciso Mini washbasin, suspended drawer and/or lateral drawer

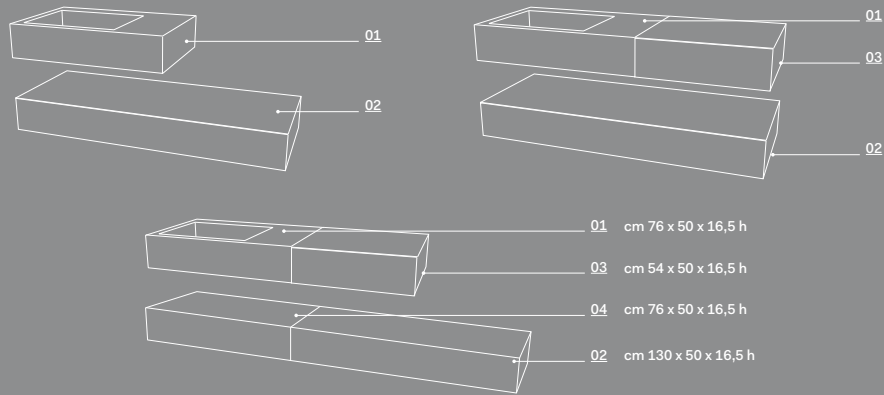

Modulo con lavabo Narciso Doppio e cassettono sospeso \ Modulo with Narciso Doppio washbasin and suspended drawer

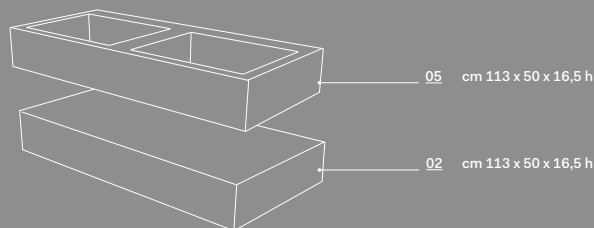

Predisposizione fori rubinetteria \ predisposition of tap holes

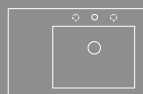
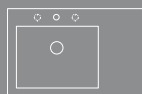

lavabo monoforo predisposto 3 fori, senza foro su richiesta
washbasin with one hole prepared 3 holes, without tap hole on requeste

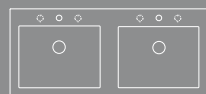

lavabo con 2 fori predisposto 6 fori, senza foro su richiesta
washbasin with two holes prepared 6 holes, without tap holes on requeste

01 \ 05 lavabo \ washbasin
Narciso Mini - Doppio

materiale \ material:
ceramica \ ceramic

finiture \ finishes:
Le Terre di Cielo



02 \ 03 \ 04 cassetti \ drawers

materiale \ material:
legno laccato \ lacquered wood

laccature \ lacquers

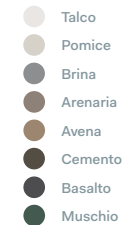

essenze \ wooden finishes



N.B.

le soluzioni con il lavabo Narciso Mini possono essere composte utilizzando sia il lavabo con bacino destro che sinistro \ the solutions with the Narciso Mini washbasin can be composed with the basin on the left or the right

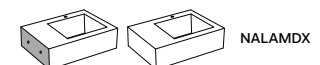
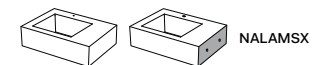

Infinite possibilità di personalizzazione \ Endless possibilities for customisation

multiplo.

L'innovativo sistema componibile di piani in ceramica e contenitori, che mette in scena sofisticate micro-architetture contemporanee che esaltano funzionalità e semplicità. Pochi elementi danno vita ad una molteplicità di combinazioni, rendendo la ceramica componibile: dal semplice piano in ceramica su cui appoggiare diverse collezioni di ciotole alla soluzione piu' completa con vano contenitore o vano portaoggetti a vista.

The innovative modular system of ceramic tops and cabinets, which stages sophisticated contemporary micro-architectures that enhance functionality and simplicity. Few elements give life to a multiplicity of combinations: from the simple ceramic top on which to place different collections of bowls to the most complete solution with a storage compartment or an open day cabinet.





lavabo eco \ eco washbasin: pomice
piano multiplo \ multiplo top: fango
struttura \ framework: nero matt
specchi oval \ oval mirrors
pouf Otto Ovale



bacinella shui \ shui bowl: brina
 piano multiplo \ multiplo top: talco
 struttura \ framework: nero matt
 mobile chiuso \ closed cabinet: muschio
 specchio \ mirror pluto



lavabo handy \ handy washbasin: pomice
 piano multiplo \ multiplo top: pomice
 struttura \ framework: nero matt
 mobile a giorno \ open day cabinet: muschio
 specchi \ mirrors eos
 portasciugamani \ towel rail



bacinella shui \ shui bowl: cemento
 piano multiplo \ multiplo top: talco
 struttura \ framework: nero matt
 mobile chiuso \ closed cabinet: talco
 specchio \ mirror pluto

lavabo handy \ handy washbasin: cemento
 piano multiplo \ multiplo top: cemento
 struttura \ framework: nero matt
 mobile a giorno \ open day cabinet: cemento
 specchi \ mirrors eos

Materiali e finiture Materials and finishes

Multiplo: lavabo + piano \ washbasin + countertop

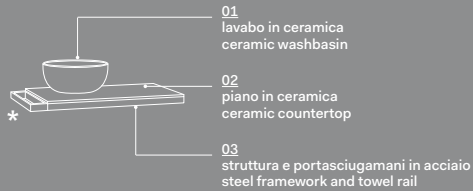

01
lavabo in ceramica
ceramic washbasin

02
piano in ceramica
ceramic countertop

03
struttura e portasciugamani in acciaio
steel framework and towel rail

* **N.B.** portasciugamani posizionabili lato destro e/o sinistro
towel rail positioned on the right and/or left side

Multiplo: lavabo + piano con mobile a giorno o chiuso \ wasbasin + top with open day cabinet or closed cabinet

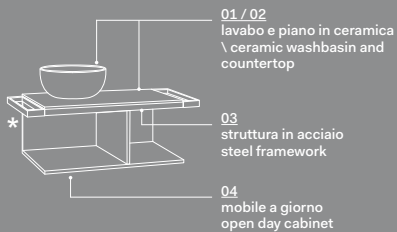

01 / 02
lavabo e piano in ceramica
\ ceramic washbasin and
countertop

03
struttura in acciaio
steel framework

04
mobile a giorno
open day cabinet

* **N.B.** portasciugamani posizionabili lato
destra e/o sinistro
towel rail positioned on the right and/or
left side

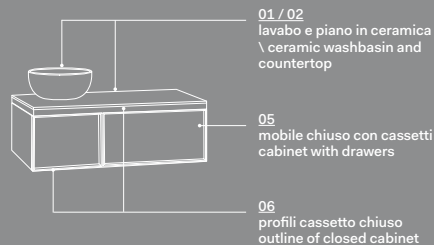

01 / 02
lavabo e piano in ceramica
\ ceramic washbasin and
countertop

05
mobile chiuso con cassetti
cabinet with drawers

06
profili cassetto chiuso
outline of closed cabinet

N.B. portasciugamani non installabili nella
versione con mobile chiuso \ towel rail can not
be installed in the version with a closed cabinet

Minimultiplo - 40 x 29

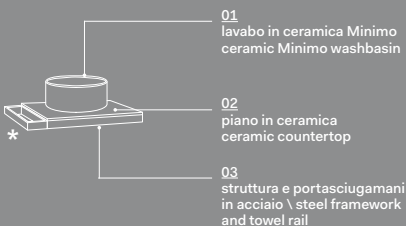

01
lavabo in ceramica Minimo
ceramic Minimo washbasin

02
piano in ceramica
ceramic countertop

03
struttura e portasciugamani
in acciaio \ steel framework
and towel rail

* **N.B.** i portasciugamani sono posizionabili affiancati al piano o sottopiano, sia lato destro che lato sinistro che frontale \ the towel rails can be placed side by side on the top or underneath, both on the right and on the left or on the front

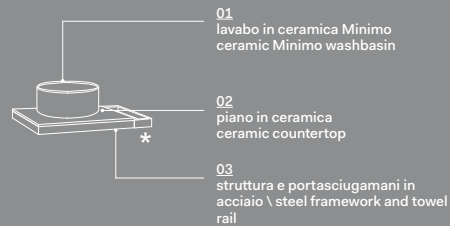

01
lavabo in ceramica Minimo
ceramic Minimo washbasin

02
piano in ceramica
ceramic countertop

03
struttura e portasciugamani in
acciaio \ steel framework and
towel rail

01 - 02 lavabo e piano \ washbasin and countertop

materiale \ material:
ceramica \ ceramic

finiture \ finishes:
Le Terre di Cielo

- Talco
- Pomice
- Brina
- Basalto
- Lavagna
- Cemento
- Fango
- Cacao
- Arenaria
- Avena
- Lino
- Agave
- Muschio
- Polvere
- Cipria
- Canapa
- Bianco Lucido \
Gloss White

03 struttura, portasciuga- mani \ framework, towel rails

materiale \ material:
metallo verniciato \
coated metal

verniciature metallo \
coated metal

- Nero Matt \ Matt Black
- Cemento

04 mobile a giorno \ open day cabinet

materiale \ material:
legno laccato o in essenza
\ lacquered or wooden finish

laccature \ lacquers

- Talco
- Pomice
- Brina
- Arenaria
- Avena
- Cemento
- Basalto
- Muschio

N.B.

la foratura sullo schienale del
mobile per il passaggio dello
scarico sifone dovrà essere
fatta a cura dell'installatore \
*The hole drilled on the back of the
cabinet for the drain trap must be
made by the installer*

05 mobile chiuso \ closed cabinet

materiale \ material:
legno laccato o in essenza
\ lacquered wood or wooden
finish

laccature \ lacquers

- Talco
- Pomice
- Brina
- Arenaria
- Avena
- Cemento
- Basalto
- Muschio

06 profili cassetto chiuso \ outline of closed cabinet

materiale \ material:
alluminio \ aluminium

verniciature \ coatings

- Nero Matt \ Matt Black
- Cemento

Infinite possibilità di personalizzazione \ Endless possibilities for customisation

multiplo

versione solo piano

\ only countertop version

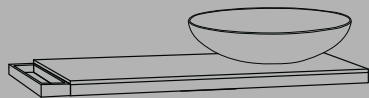

Possibilità di composizione degli elementi \ Available compositions

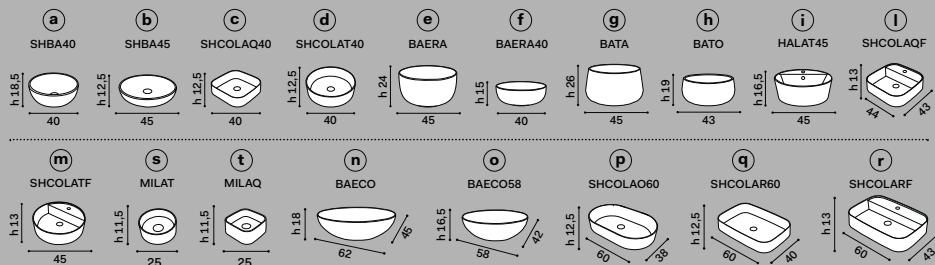

misura piano \ countertop measurements	lavabi \ washbasins	composizioni * \ compositions
40 x 29	s t	<p>N.B. 3: composizione possibile solo con rubinetto a parete composition only possible with wall-mounted tap</p>
50 x 48	a b d e f g h	
	i m	<p>N.B. 6: composizione possibile solo con rubinetto sul lavabo composition only possible with tap on washbasin</p>
	c	<p>N.B. 7: composizione possibile solo con rubinetto a parete composition only possible with wall-mounted tap</p>
	l	<p>N.B. 8: composizione possibile solo con rubinetto a parete, senza foro rubinetto sul lavabo composition only possible with wall-mounted tap, without tap hole on washbasin</p>

LEGENDA * Il numero della **COMPOSIZIONE che va riportato sul modulo d'ordine a pag. 61** definisce: \ The COMPOSITION number, that you must indicate on the Order Module on page 61, defines:

- misura del piano \ countertop measurements
- posizione del lavabo \ washbasin position
- posizione del foro rubinetto opzionale \ position of optional tap hole

10

POSIZIONE FORO RUBINETTO OPZIONALE
\ position of optional tap

N.B.
I piani nascono senza foro rubinetto (predisposizione rubinetto a parete). Il foro rubinetto sul piano può essere effettuato su richiesta con supplemento di prezzo. \ The countertops are produced without tap holes (predispositioned to wall taps). On request and for an extra charge, the tap hole can be positioned on the countertop.

Possibilità di composizione degli elementi \ Available compositions

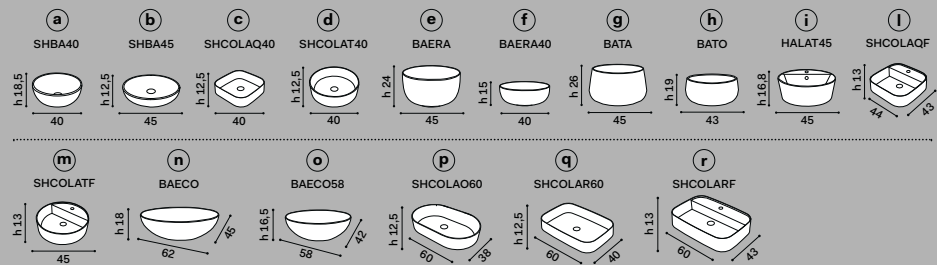

misura piano \ countertop measurements	lavabi \ washbasins	composizioni * \ compositions
70 x 48	a b d e f g h	
	i l m	<p>N.B. 13 - 14 - 15: composizioni possibili solo con rubinetto sul lavabo \ compositions only possible with tap on washbasin</p>
	c	<p>N.B. 16 - 17 - 18: composizioni possibili solo con rubinetto a parete \ compositions only possible with wall-mounted tap</p>
	n o p	
	r	<p>N.B. 21: composizione possibile solo con rubinetto sul lavabo composition only possible with tap on washbasin</p>
	q	<p>N.B. 22: composizione possibile solo con rubinetto a parete composition only possible with wall-mounted tap</p>

LEGENDA * Il numero della **COMPOSIZIONE che va riportato sul modulo d'ordine a pag. 61** definisce: \ The COMPOSITION number, that you must indicate on the Order Module on page 61, defines:

- misura del piano \ countertop measurements
- posizione del lavabo \ washbasin position
- posizione del foro rubinetto opzionale \ position of optional tap hole

10

POSIZIONE FORO RUBINETTO OPZIONALE
\ position of optional tap

N.B.
I piani nascono senza foro rubinetto (predisposizione rubinetto a parete). Il foro rubinetto sul piano può essere effettuato su richiesta con supplemento di prezzo. \ The countertops are produced without tap holes (predispositioned to wall taps). On request and for an extra charge, the tap hole can be positioned on the countertop.

Possibilità di composizione degli elementi \ Available compositions

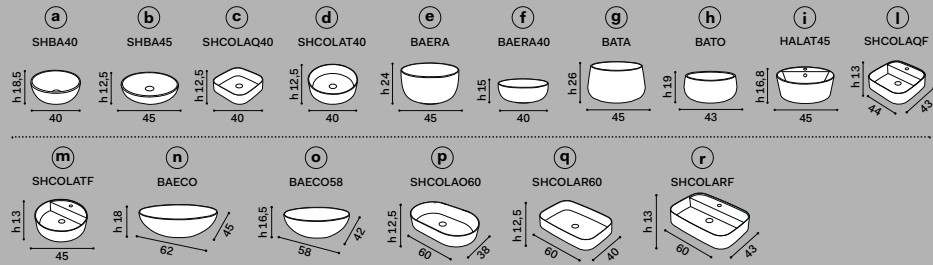

misura piano \ countertop measurements	lavabi \ washbasins	composizioni * \ compositions
90 x 48	(a) (b) (d) (e) (f) (g) (h)	<p>23 24 25 26 27</p> <p>N.B. 27: composizione possibile solo con rubinetto a parete composition only possible with wall-mounted tap</p>
	(i) (m)	<p>28 29 30</p> <p>N.B. 28 - 29 - 30: composizioni possibili solo con rubinetto sul lavabo \ compositions only possible with tap on washbasin</p>
	(l)	<p>31 32 33</p> <p>N.B. 29: composizione possibile solo con rubinetto sul lavabo \ compositions only possible with tap on washbasin</p> <p>N.B. 32 - 33: composizione possibile solo con rubinetto a parete, senza foro rubinetto sul lavabo \ composition only possible with wall-mounted tap, without tap hole on washbasin</p>
	(c)	<p>34 35 36</p> <p>N.B. 34 - 35 - 36: composizioni possibili solo con rubinetto a parete \ compositions only possible with wall-mounted tap</p>
	(r)	<p>37</p> <p>N.B. 37: composizione possibile solo con rubinetto sul lavabo composition only possible with tap on washbasin</p>
	(n) (o) (p) (q)	<p>38</p> <p>N.B. 38: composizione possibile solo con rubinetto a parete composition only possible with wall-mounted tap</p>

LEGENDA *

Il numero della **COMPOSIZIONE che va riportato sul modulo d'ordine a pag. 61** definisce: \ The COMPOSITION number, that you must indicate on the Order Module on page 61, defines:

- misura del piano \ countertop measurements
- posizione del lavabo \ washbasin position
- posizione del foro rubinetto opzionale \ position of optional tap hole

10 POSIZIONE FORO RUBINETTO OPZIONALE \ position of optional tap

N.B.
I piani nascono senza foro rubinetto (predisposizione rubinetto a parete). Il foro rubinetto sul piano può essere effettuato su richiesta con supplemento di prezzo. \ The countertops are produced without tap holes (predispositioned to wall taps). On request and for an extra charge, the tap hole can be positioned on the countertop.

Possibilità di composizione degli elementi \ Available compositions

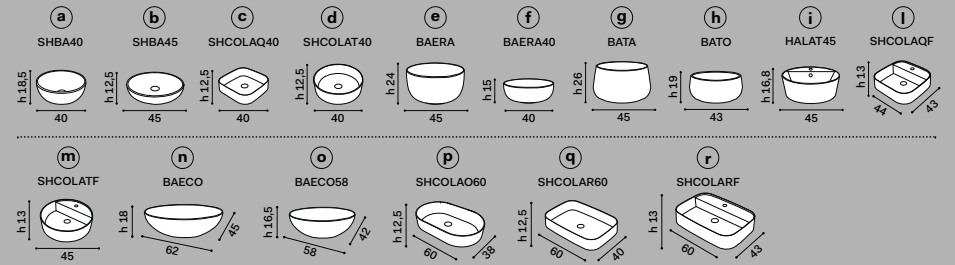

misura piano \ countertop measurements	lavabi \ washbasins	composizioni * \ compositions
120 x 48	(a) (b) (d) (e) (f) (g) (h)	<p>39 40 41 42 43</p>
	(i) (l) (m)	<p>44 45 46 47</p> <p>N.B. 44 - 45 - 46 - 47: composizioni possibili solo con rubinetto sul lavabo \ compositions only possible with tap on washbasin</p>
	(c)	<p>48 49 50 51 52</p>
	(n) (o) (p)	<p>53 54 55 56 57 58</p>
	(q)	<p>59 60 61</p> <p>N.B. 59 - 60 - 61: composizioni possibili solo con rubinetto a parete \ compositions only possible with wall-mounted tap</p>
	(r)	<p>62 63 64</p> <p>N.B. 62 - 63 - 64: composizioni possibili solo con rubinetto sul lavabo \ compositions only possible with tap on washbasin</p>

LEGENDA *

Il numero della **COMPOSIZIONE che va riportato sul modulo d'ordine a pag. 61** definisce: \ The COMPOSITION number, that you must indicate on the Order Module on page 61, defines:

- misura del piano \ countertop measurements
- posizione del lavabo \ washbasin position
- posizione del foro rubinetto opzionale \ position of optional tap hole

10 POSIZIONE FORO RUBINETTO OPZIONALE \ position of optional tap

N.B.
I piani nascono senza foro rubinetto (predisposizione rubinetto a parete). Il foro rubinetto sul piano può essere effettuato su richiesta con supplemento di prezzo. \ The countertops are produced without tap holes (predispositioned to wall taps). On request and for an extra charge, the tap hole can be positioned on the countertop.

Possibilità di composizione degli elementi \ Available compositions

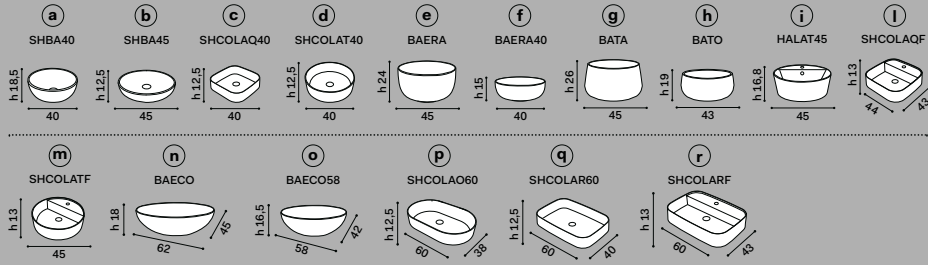

misura piano \ countertop measurements	lavabi \ washbasins	composizioni * \ compositions
140 x 48	a b d e f g h	65 66 67 68 69
	i l m	70 71 72 73 <i>N.B. 70 - 71 - 72 - 73: composizioni possibili solo con rubinetto sul lavabo \ compositions only possible with tap on washbasin</i>
	c	74 75 76 77 78 79
	n o p	80 81 82 83 84 85 86 87
	q	88 89 <i>N.B. 90 - 91 - 92 - 93: composizioni possibili solo con rubinetto a parete \ compositions only possible with wall-mounted tap</i>
	r	90 91 92 93 <i>N.B. 94 - 95 - 96 - 97: composizioni possibili solo con rubinetto sul lavabo \ compositions only possible with tap on washbasin</i>
		94 95 96 97

LEGENDA * Il numero della **COMPOSIZIONE** che va riportato sul modulo d'ordine a pag. 61 definisce: \ The COMPOSITION number, that you must indicate on the Order Module on page 61, defines:

- misura del piano \ countertop measurements
- posizione del lavabo \ washbasin position
- posizione del foro rubinetto opzionale \ position of optional tap hole

POSIZIONE FORO RUBINETTO OPZIONALE \ position of optional tap

N.B. I piani nascono senza foro rubinetto (predisposizione rubinetto a parete). Il foro rubinetto sul piano può essere effettuato su richiesta con supplemento di prezzo. \ The countertops are produced without tap holes (predispositioned to wall taps). On request and for an extra charge, the tap hole can be positioned on the countertop.

modulo ordine
multiplo versione solo piano \ only benchtop version

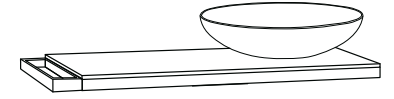

1. indica la composizione scelta \ indicate the chosen composition **obbligatorio \ mandatory**

numero composizione \ composition number n°.....

- rubinetto a parete \ wall mounted tap
- rubinetto su piano opzionale \ optional countertop tap
- piani senza fori (piletta-rubinetto) \ countertops without holes (waste-tap)

N.B. I PIANI NASCONO SENZA FORO RUBINETTO (predisposizione rubinetto a parete). Il foro rubinetto sul piano può essere effettuato su richiesta con un costo di 20 € (prezzo netto + IVA). \ The countertops are produced without tap holes (predispositioned to wall taps). On request the tap hole can be positioned on the countertop, with an extra charge of €20 (nett + IVA)

2. indica il lavabo \ indicate the washbasin **obbligatorio \ mandatory**

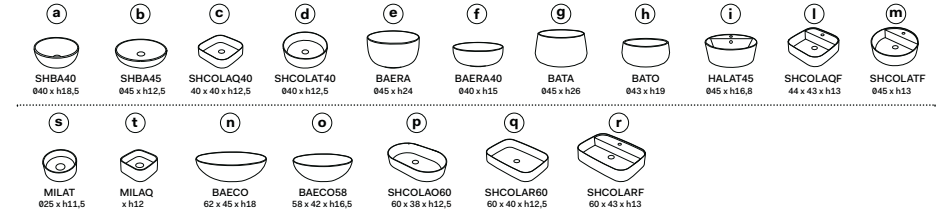

3. indica la misura del piano \ indicate the dimensions of the countertop **obbligatorio \ mandatory**

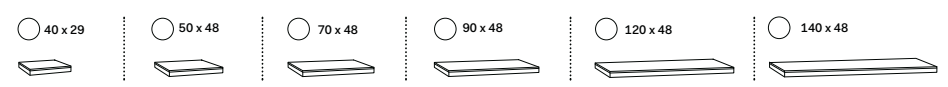

4. indica il portasciugamani \ indicate the towel rail

Piani \ tops: 50 - 70 - 90 - 120 - 140

- nessuno \ none
- singolo (dx o sx) \ single (right or left)
- doppio \ double

Piano \ top: 40 Minimultiplo

- nessuno \ none
- singolo affiancato oppure sotto (dx o sx) \ single aligned or under (left or right)
- doppio \ double
- frontale affiancato oppure sotto \ front aligned or under

5. Indica le finiture \ Indicate finishes

Talco Pomicie Brina Basalto Lavagna Cemento Fango Cacao Arenaria Avena Lino Agave Muschio Polvere Cipria Canapa Bianco Lucido Gloss White

Talco Pomicie Brina Basalto Lavagna Cemento Fango Cacao Arenaria Avena Lino Agave Muschio Polvere Cipria Canapa Bianco Lucido Gloss White

Nero Matt Matt Black Cemento

firma per accettazione \ signature for acceptance

multiplo versione piano e mobile a giorno

version with countertop and
open day cabinet

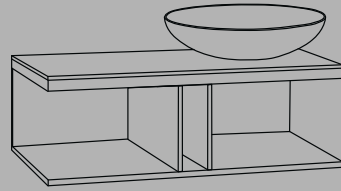

Possibilità di composizione degli elementi \ Available compositions

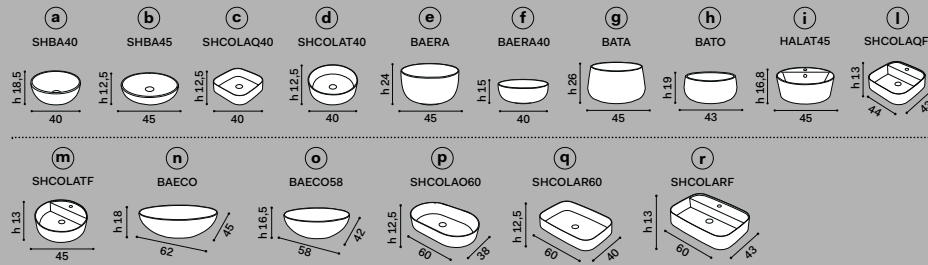

misura mobile \\ countertop measurements	lavabi \\ washbasins	composizioni * \\ compositions
50 x 48 x h39 	a b d e f g h	 4 5
	i m	 6 N.B. 6: composizione possibile solo con rubinetto sul lavabo composition only possible with tap on washbasin
	c	 7 N.B. 7: composizione possibile solo con rubinetto a parete composition only possible with wall-mounted tap
	l	 8 N.B. 8: composizione possibile solo con rubinetto a parete, senza foro rubinetto sul lavabo composition only possible with wall-mounted tap, without tap hole on washbasin

LEGENDA * Il numero della **COMPOSIZIONE che va riportato sul modulo d'ordine a pag. 67** definisce: \\ The COMPOSITION number, that you must indicate on the Order Module on page 67, defines:

- misura del mobile \\ cabinet measurements
- posizione del lavabo \\ washbasin position
- posizione del foro rubinetto opzionale \\ position of optional tap hole



POSIZIONE FORO RUBINETTO OPZIONALE \\ position of optional tap

N.B. I piani nascono senza foro rubinetto (predisposizione rubinetto a parete). Il foro rubinetto sul piano può essere effettuato su richiesta con supplemento di prezzo. \\ The countertops are produced without tap holes (predispositioned to wall taps). On request and for an extra charge, the tap hole can be positioned on the countertop.

Possibilità di composizione degli elementi \ Available compositions

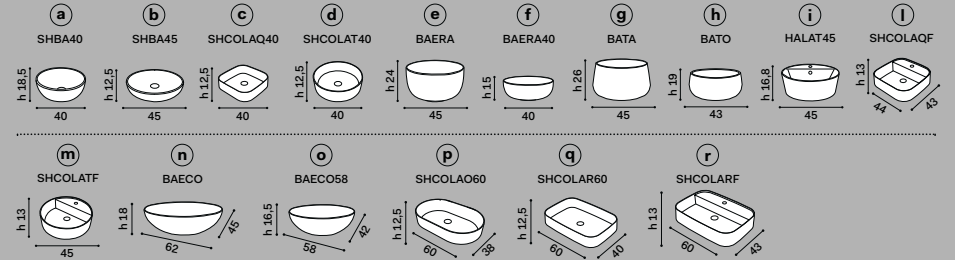

misura mobile \\ cabinet measurements	lavabi \\ washbasins	composizioni * \\ compositions
70 x 48 h39 	a b d e f g h	 9 10 11 12
	i l m	 13 14 15 N.B. 13 - 14 - 15: composizioni possibili solo con rubinetto sul lavabo \\ compositions only possible with tap on washbasin
	c	 16 17 18 N.B. 16 - 17 - 18: composizioni possibili solo con rubinetto a parete compositions only possible with wall-mounted tap
	n o p	 19 20
	r	 21 N.B. 21: composizione possibile solo con rubinetto sul lavabo \\ composition only possible with tap on washbasin
	q	 22 N.B. 22: composizione possibile solo con rubinetto a parete composition only possible with wall-mounted tap

LEGENDA * Il numero della **COMPOSIZIONE che va riportato sul modulo d'ordine a pag. 69** definisce: \\ The COMPOSITION number, that you must indicate on the Order Module on page 69, defines:

- misura del mobile \\ cabinet measurements
- posizione del lavabo \\ washbasin position
- posizione del foro rubinetto opzionale \\ position of optional tap hole



POSIZIONE FORO RUBINETTO OPZIONALE \\ position of optional tap

N.B. I piani nascono senza foro rubinetto (predisposizione rubinetto a parete). Il foro rubinetto sul piano può essere effettuato su richiesta con supplemento di prezzo. \\ The countertops are produced without tap holes (predispositioned to wall taps). On request and for an extra charge, the tap hole can be positioned on the countertop.

Possibilità di composizione degli elementi \ Available compositions

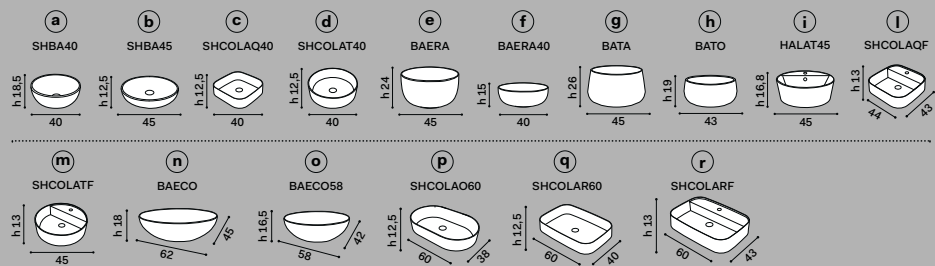

misura mobile cabinet measurements	lavabi washbasins	composizioni * compositions
90 x 48 x h39 	a b d e f g h	<p>N.B. 27: composizione possibile solo con rubinetto a parete composition only possible with wall-mounted tap</p>
	i m	<p>N.B. 28 - 29 - 30: composizioni possibili solo con rubinetto sul lavabo compositions only possible with tap on washbasin</p>
	l	<p>N.B. 29: composizione possibile solo con rubinetto sul lavabo compositions only possible with tap on washbasin</p> <p>N.B. 32 - 33: composizione possibile solo con rubinetto a parete, senza foro rubinetto sul lavabo composition only possible with wall-mounted tap, without tap hole on washbasin</p>
	c	<p>N.B. 34 - 35 - 36: composizioni possibili solo con rubinetto a parete compositions only possible with wall-mounted tap</p>
	r	<p>N.B. 37: composizione possibile solo con rubinetto sul lavabo composition only possible with tap on washbasin</p>
	n o p q	<p>N.B. 38: composizione possibile solo con rubinetto a parete composition only possible with wall-mounted tap</p>

LEGENDA *

Il numero della **COMPOSIZIONE che va riportato sul modulo d'ordine a pag. 69** definisce: \ The COMPOSITION number, that you must indicate on the Order Module on page 69, defines:

- misura del mobile \ cabinet measurements
- posizione del lavabo \ washbasin position
- posizione del foro rubinetto opzionale \ position of the optional tap hole

POSIZIONE FORO RUBINETTO OPZIONALE
position of optional tap

N.B.
I piani nascono senza foro rubinetto (predisposizione rubinetto a parete). Il foro rubinetto sul piano può essere effettuato su richiesta con supplemento di prezzo. \ The countertops are produced without tap holes (predispositioned to wall taps). On request and for an extra charge, the tap hole can be positioned on the countertop.

Possibilità di composizione degli elementi \ Available compositions

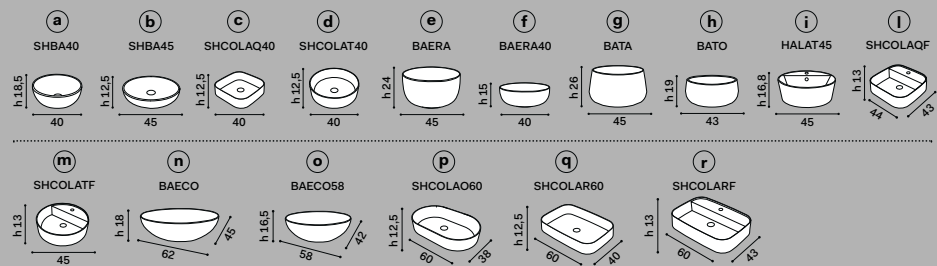

misura mobile cabinet measurements	lavabi washbasins	composizioni * compositions
120 x 48 x h39 	a b d e f g h	
	i l m	<p>N.B. 44 - 45 - 46 - 47: composizioni possibili solo con rubinetto sul lavabo compositions only possible with tap on washbasin</p>
	c	<p>N.B. 98 - 99 - 100 - 101: composizioni possibili solo con rubinetto a parete compositions only possible with wall-mounted tap</p>
	n o p	
	q	<p>N.B. 59 - 60 - 61: composizioni possibili solo con rubinetto a parete compositions only possible with wall-mounted tap</p>
	r	<p>N.B. 62 - 63 - 64: composizioni possibili solo con rubinetto sul lavabo compositions only possible with tap on washbasin</p>

LEGENDA *

Il numero della **COMPOSIZIONE che va riportato sul modulo d'ordine a pag. 69** definisce: \ The COMPOSITION number, that you must indicate on the Order Module on page 69, defines:

- misura del mobile \ cabinet measurements
- posizione del lavabo \ washbasin position
- posizione del foro rubinetto opzionale \ position of the optional tap hole

POSIZIONE FORO RUBINETTO OPZIONALE
position of optional tap

N.B.
I piani nascono senza foro rubinetto (predisposizione rubinetto a parete). Il foro rubinetto sul piano può essere effettuato su richiesta con supplemento di prezzo. \ The countertops are produced without tap holes (predispositioned to wall taps). On request and for an extra charge, the tap hole can be positioned on the countertop.

Possibilità di composizione degli elementi \ Available compositions

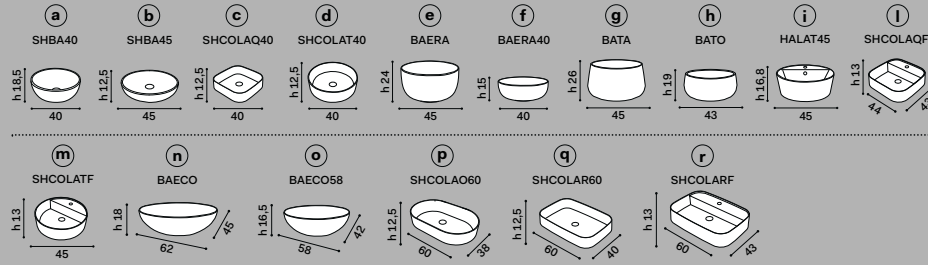

misura mobile \ cabinet measurements		lavabi \ washbasins		composizioni * \ compositions					
140 x 48 x h39	a b d e f g h	65	66	67	68	69			
	i l m	70	71	72	73				
	c	74	75	76	77	78	79		
	n o p	80	81	82	83	84	85	86	87
	q	88	89	90	91	92	93		
	r	94	95	96	97				

N.B. 70 - 71 - 72 - 73: composizioni possibili solo con rubinetto sul lavabo \ compositions only possible with tap on washbasin

N.B. 90 - 91 - 92 - 93: composizioni possibili solo con rubinetto a parete \ compositions only possible with wall-mounted tap

N.B. 94 - 95 - 96 - 97: composizioni possibili solo con rubinetto sul lavabo \ compositions only possible with tap on washbasin

LEGENDA * Il numero della **COMPOSIZIONE che va riportato sul modulo d'ordine a pag. 69** definisce: \ The COMPOSITION number, that you must indicate on the Order Module on page 69, defines:

- misura del mobile \ cabinet measurements
- posizione del lavabo \ washbasin position
- posizione del foro rubinetto opzionale \ position of optional tap hole

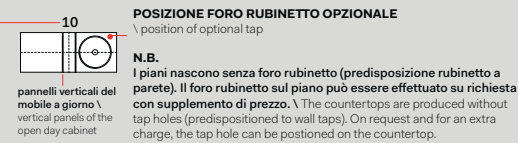

modulo ordine
multiplo versione piano e mobile a giorno \ version with countertop and open day cabinet

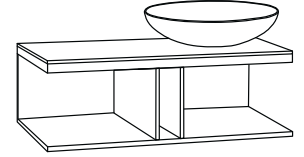

1. indica la composizione scelta \ indicate the chosen composition **obbligatorio \ mandatory**

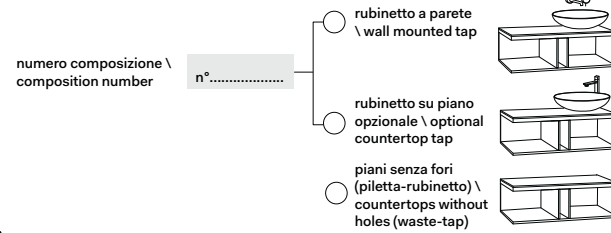

N.B. I PIANI NASCONO SENZA FORO RUBINETTO (predisposizione rubinetto a parete). Il foro rubinetto sul piano può essere effettuato su richiesta con un costo di 20 € (prezzo netto + IVA). \ The countertops are produced without tap holes (predispositioned to wall taps). On request the tap hole can be positioned on the countertop, with an extra charge of €20 (nett + IVA)

2. indica il lavabo \ indicate the washbasin **obbligatorio \ mandatory**

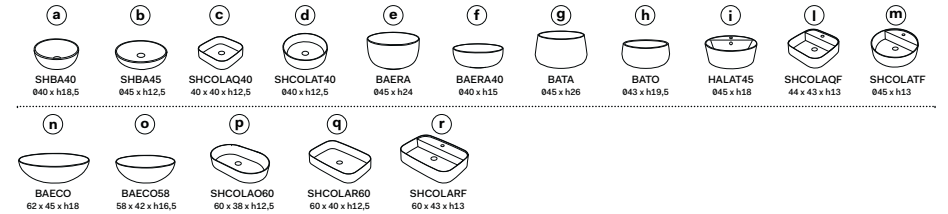

3. indica la misura del mobile \ indicate the dimensions of the cabinet **obbligatorio \ mandatory**

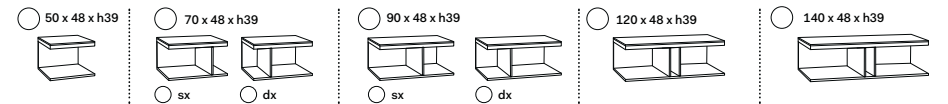

4. indica il portasciugamani \ indicate the towel rail **obbligatorio \ mandatory**

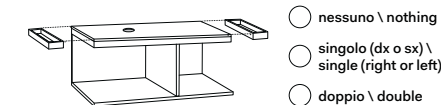

5. Indica le finiture \ Indicate finishes

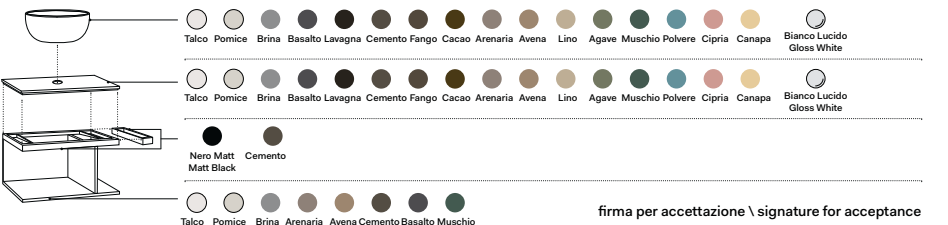

multiplo versione piano e mobile chiuso

\ version with countertop
and closed cabinet.

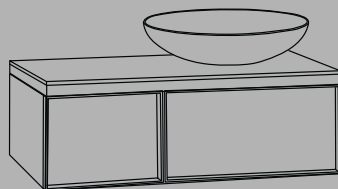

Possibilità di composizione degli elementi \ Available compositions

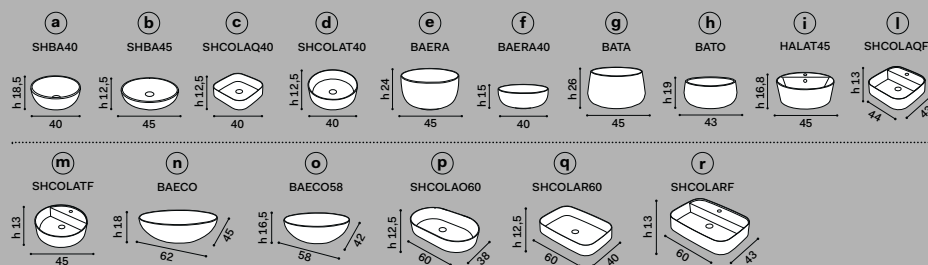

misura mobile \ cabinet measurements	lavabi \ washbasins	composizioni* \ compositions
50 x 48 x h37 mobile con 1 cassetto \ cabinet with one drawers	a b d e f g h	4 5
	i m	6 N.B. 6: composizione possibile solo con rubinetto sul lavabo composition only possible with tap on washbasin
	c	7 N.B. 7: composizione possibile solo con rubinetto a parete composition only possible with wall-mounted tap
	l	8 N.B. 8: composizione possibile solo con rubinetto a parete, senza foro rubinetto sul lavabo composition only possible with wall-mounted tap, without tap hole on washbasin

LEGENDA

* Il numero della **COMPOSIZIONE** che va riportato sul modulo d'ordine a pag. 73 definisce: \ The COMPOSITION number, that you must indicate on the Order Module on page 73, defines:

- misura del mobile \ cabinet measurements
- posizione del lavabo \ washbasin position
- posizione del foro rubinetto opzionale \ position of optional tap hole



POSIZIONE FORO RUBINETTO OPZIONALE
\ position of optional tap

N.B.
I piani nascono senza foro rubinetto (predisposizione rubinetto a parete). Il foro rubinetto sul piano può essere effettuato su richiesta con supplemento di prezzo. \ The countertops are produced without tap holes (predispositioned to wall taps). On request and for an extra charge, the tap hole can be positioned on the countertop.

Possibilità di composizione degli elementi \ Available compositions

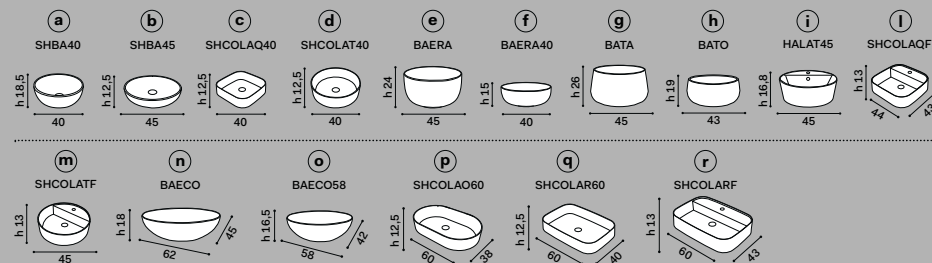

misura mobile \ cabinet measurements	lavabi \ washbasins	composizioni* \ compositions
70 x 48 x h37 mobile con 1 cassetto \ cabinet with one drawers	a b d e f g h	9 10 11 12
	i l m	13 14 15 N.B. 13 - 14 - 15: composizioni possibili solo con rubinetto sul lavabo \ compositions only possible with tap on washbasin
	c	16 17 18 N.B. 16 - 17 - 18: composizioni possibili solo con rubinetto a parete \ compositions only possible with wall-mounted tap
	n o p	19 20
	r	21 N.B. 21: composizione possibile solo con rubinetto sul lavabo \ composition only possible with tap on washbasin
	q	22 N.B. 22: composizione possibile solo con rubinetto a parete \ composition only possible with wall-mounted tap

LEGENDA

* Il numero della **COMPOSIZIONE** che va riportato sul modulo d'ordine a pag. 73 definisce: \ The COMPOSITION number, that you must indicate on the Order Module on page 73, defines:

- misura del mobile \ cabinet measurements
- posizione del lavabo \ washbasin position
- posizione del foro rubinetto opzionale \ position of optional tap hole



POSIZIONE FORO RUBINETTO OPZIONALE
\ position of optional tap

N.B.
I piani nascono senza foro rubinetto (predisposizione rubinetto a parete). Il foro rubinetto sul piano può essere effettuato su richiesta con supplemento di prezzo. \ The countertops are produced without tap holes (predispositioned to wall taps). On request and for an extra charge, the tap hole can be positioned on the countertop.

Possibilità di composizione degli elementi \ Available compositions

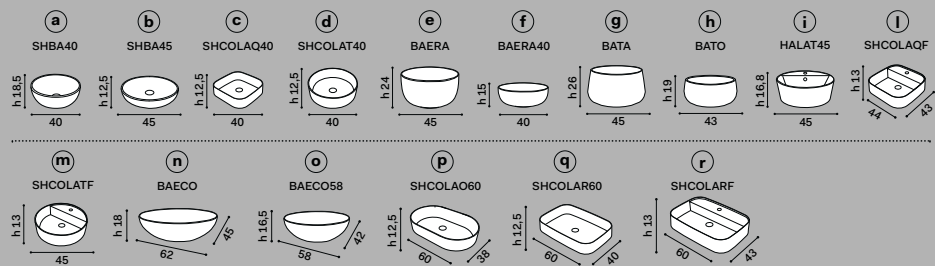

misura mobile cabinet measurements	lavabi washbasins	composizioni * compositions
90 x 48 x h37 mobile con 2 cassetti cabinet with two drawers	a b d e f g h	23 26
	i m	28 30 N.B. 28 - 30: composizioni possibili solo con rubinetto sul lavabo \ compositions only possible with tap on washbasin
	l	32 33 N.B. 32 - 33: composizione possibile solo con rubinetto a parete, senza foro rubinetto sul lavabo \ composition only possible with wall-mounted tap, without tap hole on washbasin
	c	34 36 N.B. 34 - 36: composizioni possibili solo con rubinetto a parete \ compositions only possible with wall-mounted tap

LEGENDA *

Il numero della **COMPOSIZIONE che va riportato sul modulo d'ordine a pag. 75** definisce: \ The COMPOSITION number, that you must indicate on the Order Module on page 75, defines:

- misura del mobile \ cabinet measurements
- posizione del lavabo \ washbasin position
- posizione del foro rubinetto opzionale \ position of optional tap hole



pannello verticale tra i cassetti \ vertical panel between drawers

POSIZIONE FORO RUBINETTO OPZIONALE \ position of optional tap

N.B.
 I piani nascono senza foro rubinetto (predisposizione rubinetto a parete). Il foro rubinetto sul piano può essere effettuato su richiesta con supplemento di prezzo. \ The countertops are produced without tap holes (predispositioned to wall taps). On request and for an extra charge, the tap hole can be positioned on the countertop.

Possibilità di composizione degli elementi \ Available compositions

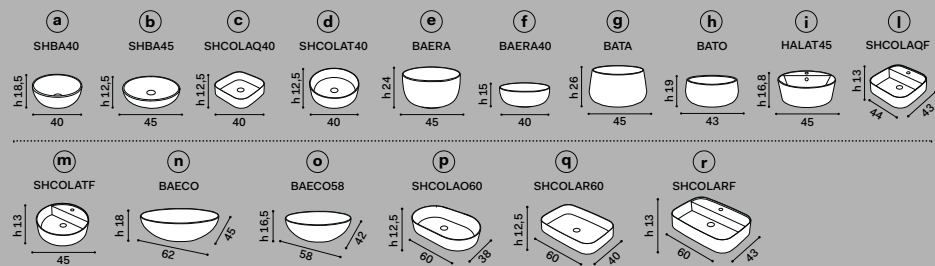

misura mobile cabinet measurements	lavabi washbasins	composizioni * compositions
120 x 48 x h37 mobile con 2 cassetti cabinet with two drawers	a b d e f g h	39 40 41 42 43
	i l m	44 45 46 47 N.B. 44 - 45 - 46 - 47: composizioni possibili solo con rubinetto sul lavabo \ compositions only possible with tap on washbasin
	c	98 99 100 101 N.B. 98 - 99 - 100 - 101: composizioni possibili solo con rubinetto a parete \ compositions only possible with wall-mounted tap
	n o p	53 54 55 56 57 58
	q	59 60 61 N.B. 59 - 60 - 61: composizioni possibili solo con rubinetto a parete \ compositions only possible with wall-mounted tap
	r	62 63 64 N.B. 62 - 63 - 64: composizioni possibili solo con rubinetto sul lavabo \ compositions only possible with tap on washbasin

LEGENDA *

Il numero della **COMPOSIZIONE che va riportato sul modulo d'ordine a pag. 75** definisce: \ The COMPOSITION number, that you must indicate on the Order Module on page 75, defines:

- misura del mobile \ cabinet measurements
- posizione del lavabo \ washbasin position
- posizione del foro rubinetto opzionale \ position of optional tap hole



pannello verticale tra i cassetti \ vertical panel between drawers

POSIZIONE FORO RUBINETTO OPZIONALE \ position of optional tap

N.B.
 I piani nascono senza foro rubinetto (predisposizione rubinetto a parete). Il foro rubinetto sul piano può essere effettuato su richiesta con supplemento di prezzo. \ The countertops are produced without tap holes (predispositioned to wall taps). On request and for an extra charge, the tap hole can be positioned on the countertop.

Possibilità di composizione degli elementi \ Available compositions

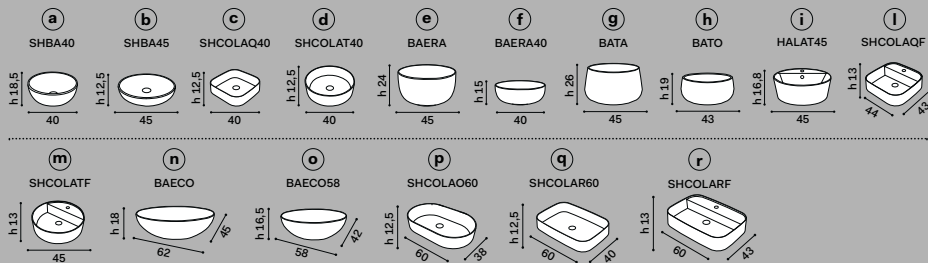

misura mobile \ cabinet measurements		lavabi \ washbasins		composizioni * \ compositions	
140 x 48 x h37	mobile con 3 cassetti \ cabinet with three drawers	a, b, d, e, f, g, h		65, 66, 67, 68, 69	
		i, l, m		70, 71, 72, 73	N.B. 70 - 71 - 72 - 73: composizioni possibili solo con rubinetto sul lavabo \ compositions only possible with tap on washbasin
		c		74, 75, 102, 78	N.B. 102: composizione possibile solo con rubinetto a parete \ composition only possible with wall-mounted tap
		n, o, p		79, 80, 81	
		q		82, 83, 84, 85, 86, 87	
		r		88, 89	
		q		90, 91, 92, 93	N.B. 90 - 91 - 92 - 93: composizioni possibili solo con rubinetto a parete \ compositions only possible with wall-mounted tap
		r		94, 95, 96, 97	N.B. 94 - 95 - 96 - 97: composizioni possibili solo con rubinetto sul lavabo \ compositions only possible with tap on washbasin

LEGENDA * Il numero della **COMPOSIZIONE che va riportato sul modulo d'ordine a pag. 75** definisce: \ The COMPOSITION number, that you must indicate on the Order Module on page 75, defines:

- misura del mobile \ cabinet measurements
- posizione del lavabo \ washbasin position
- posizione del foro rubinetto opzionale \ position of optional tap hole

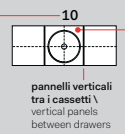

POSIZIONE FORO RUBINETTO OPZIONALE \ position of optional tap

N.B. I piani nascono senza foro rubinetto (predisposizione rubinetto a parete). Il foro rubinetto sul piano può essere effettuato su richiesta con supplemento di prezzo. \ The countertops are produced without tap holes (predispositioned to wall taps). On request and for an extra charge, the tap hole can be positioned on the countertop.

modulo ordine
multiplo versione piano e mobile
chiuso \ version with countertop and closed cabinet

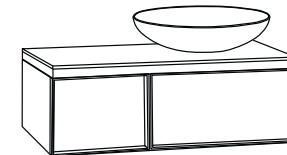

1. indica la composizione scelta \ indicate the chosen composition **obbligatorio \ mandatory**

numero composizione \ composition number n°.....

- rubinetto a parete \ wall mounted tap
- rubinetto sul piano opzionale \ optional countertop tap
- piani senza fori (piletta-rubinetto) \ countertops without holes (waste-tap)

N.B. I PIANI NASCONO SENZA FORO RUBINETTO (predisposizione rubinetto a parete). Il foro rubinetto sul piano può essere effettuato su richiesta con un costo di 20 € (prezzo netto + IVA). \ The countertops are produced without tap holes (predispositioned to wall taps). On request the tap hole can be positioned on the countertop, with an extra charge of €20 (nett + IVA)

2. indica il lavabo \ indicate the washbasin **obbligatorio \ mandatory**

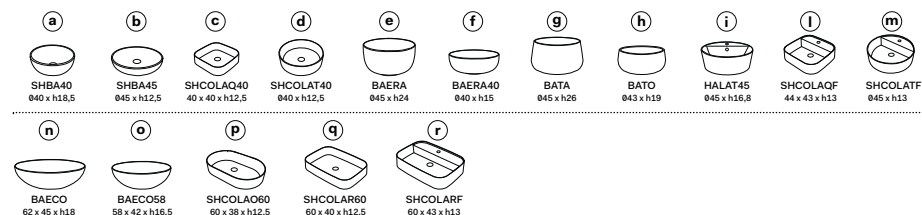

3. indica la misura del mobile \ indicate the dimensions of the cabinet **obbligatorio \ mandatory**

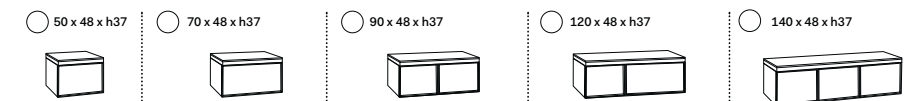

4. Indica le finiture \ Indicate finishes

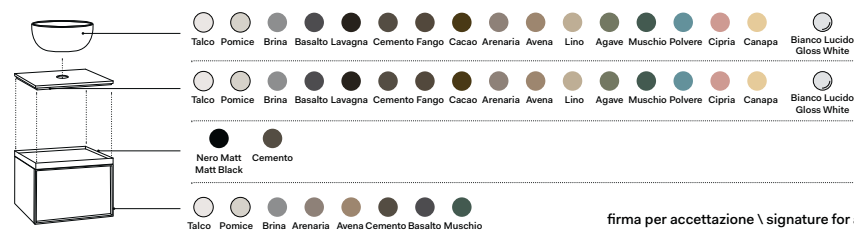

firma per accettazione \ signature for acceptance

accessori.

Portasciugamani e strutture in metallo in quattro diverse finiture, Nero matt, Bronzo spazzolato, Cromo e Cemento, mensole ed accessori in LivingTec bianco: elementi tra loro facilmente componibili in base alle proprie esigenze di spazio, riescono ad offrire alla stanza da bagno una molteplicità di soluzioni.

Towel rails and metal structures in four different finishings, Black matt, Brushed bronze, Chrome and Cemento, shelves and accessories in white LivingTec: elements that can be combined on the basis of one's need for space, and are able to offer multifaceted solutions for the bathroom.





portasciugamani versione
rettangolare \ towel rails,
rectangular version



elemento porta sapone e
portasciugamani \
soap holder and towel rail element



mensola in LivingTec
portasapone \\
shelf in LivingTec, soap holder

portasciugamani versione ovale \\
towel rails, oval version





portarotolo \\
roll holder



elemento porta sapone
e portasciugamani \\
soap holder and towel rail element



sacca
portabiancheria /
laundry bag



portasciugamani versione
rettangolare / towel rail,
rectangular version

sacca
portabiancheria /
laundry bag





mensola in LivingTec
portasapone
shelf in LivingTec, soap holder
portasciugamani
versione ovale/ towel rail oval
version

Accessori \ Accessories

Portasciugamani versione rettangolare
Towel rails, rectangular version

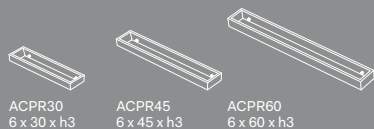
ACPR30
6 x 30 x h3ACPR45
6 x 45 x h3ACPR60
6 x 60 x h3

Portasciugamani versione ovale
Towel rails, oval version

ACPT30
6 x 30 x h3ACPT45
6 x 45 x h3ACPT60
6 x 60 x h3

Barra porta accessori
Tray for accessories

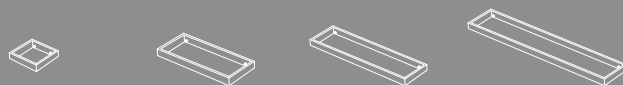
ACB12
12 x 12 x h3ACB30
12 x 30 x h3ACB50
12 x 50 x h3ACB72
12 x 72 x h3

Mensola in LivingTec
Shelf in LivingTec

ACM12
12 x 12 x h2ACM30
12 x 30 x h2ACM50
12 x 50 x h2ACM72
12 x 72 x h2

Porta sapone in LivingTec
Soap holder in LivingTec

ACMP1
12 x 12 x h2ACMP2
12 x 30 x h2

Bicchieri e dispenser in LivingTec
Glass and dispenser in LivingTec

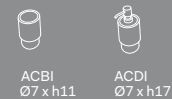
ACBI
Ø7 x h11ACDI
Ø7 x h17

Porta scopino in LivingTec
Toilet brush holder in LivingTec

ACPS
12 x 12 x h35

Porta rotolo
Roll holder

ACBR
12 x 14 x h3

Gancio
Hook

ACGA
3 x 3 x h4,5

Porta bicchiere o
dispenser in LivingTec
Glass or dispenser holders in
LivingTec

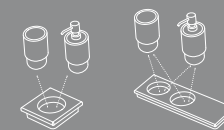
ACMP4
12 x 12 x h2ACMP5
12 x 30 x h2

Porta sapone con foro per
bicchiere o dispenser in LivingTec
Soap dish with holes for a glass
or dispenser in LivingTec

ACMP3
12 x 30 x h2

Esempi di composizione \ Example of composition

Accessori \ Accessories



ACMP1
12 x 12 x h2

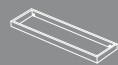

ACB50
12 x 50 x h3



ACMP4
12 x 12 x h2



ACB30
12 x 30 x h3



ACDI
Ø7 x h17



ACPS
12 x 12 x h35



ACB12
12 x 12 x h3

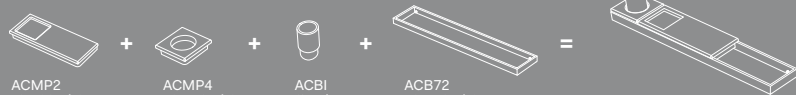

ACMP2
12 x 30 x h2



ACMP4
12 x 12 x h2



ACBI
Ø7 x h11



ACB72
12 x 72 x h3

**Finiture barre, portasciugamani,
porta rotolo, porta scopino, gancio **
Tray, towel rack, toilet paper
holder, toilet brush holder and
hook finishes

verniciature \ coatings

Finiture \ Finishes:

- Nero Matt \ Matt Black
- Cemento
- Cromo
- Bronzo Spazzolato \
Brushed Bronze

**Finiture accessori
in LivingTec **
Accessory in LivingTec finishes

Finiture \ Finishes:

- Bianco Matt \
Matt White

Le eventuali variazioni di colore non possono essere considerate un difetto in quanto garanzia della fattura completamente manuale e artigianale di un prodotto unico e di qualità. \ The possible variations of the colour cannot be considered as defect, but as a guarantee of the completely artisan manufacturing of this unique and high quality product.

vasche\ bath tubs.

febe, dafne, cibeles L

Fascino classico e forme contemporanee per vivere il bagno come un luogo di assoluto relax. Le tre nuove vasche da bagno sono vere e proprie sculture plasmate da linee morbide. Connotate dalla piacevole tattilità data dall'utilizzo del LivingTec, le tre vasche sono disponibili nelle finiture Bianco Matt, Brina e Arenaria delle "Terre di Cielo".

Classic charm and contemporary forms to experience the bathroom as a place of absolute relaxation. The new bath tubs are genuine sculptures shaped by soft lines. Connoted by the pleasant tactility given by the use of LivingTec, the three bathtubs are available in Bianco Matt, Brina and Arenaria, finishes from the "Terre di Cielo".





vasca \ bath tub febe:
 bianco matt \ matt white
 wc e bidet sospesi enjoy \
 wall-hung enjoy wc and bidet: talco
 portasciugamani \ towel rail





vasca \ bath tub
dafne: brina



vasca \ bath tub
cibele L: bianco matt \ matt white

vasca \ bath tub
febe: brina



vasca \ bath tub
dafne: arenaria





vasca \ bath tub
febe: bianco matt \ matt white



vasca \ bath tub
dafne: bianco matt \ matt white

Materiali e finiture \ Materials and finishes

Vasca Bath tub Cibebe L - 161 x 88 x 61 h

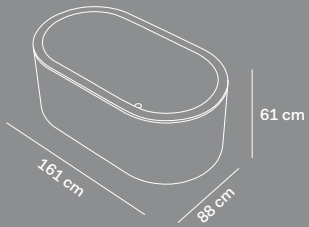

Vasca Febe - 140 x 80 x 57 h

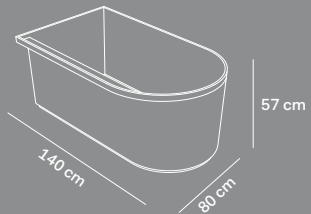

Vasca Dafne - 130 x 80 x 55 h

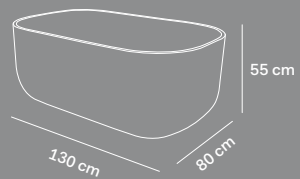

Cibebe L, Febe, Dafne

materiale \ material:
LivingTec

finiture \ finishes:

- Bianco Matt \ Matt White
- Brina
- Arenaria

specchi\ mirrors.

elio, elio slim, eos, eos-c, simple
box, simple tall box, pan, round,
round box, oval, oval box, argo,
pluto, polifemo.

Non solo specchi, ma anche utili e capienti contenitori ispirati alla purezza delle forme disponibili in versione verticale e orizzontale. Un unico tratto, che converge in una progettazione di prodotti dalle linee essenziali, senza mai tralasciare la poesia dell'oggetto, segno stilistico che contraddistingue tutti i prodotti.

Not only mirrors, but also useful and capacious cabinets inspired by the purity of the shapes available in vertical and horizontal versions. A single trait that converges into a design of products with essential lines, without ever sacrificing the poetry of the object, a stylistic sign that distinguishes all products.



Specchi \ Mirror



specchio Elio
Elio mirror
145 x 50 x 31 cm - SPELCL
pag. 216



specchio Elio Slim
Elio Slim mirror
145 x 50 x 15 cm
SPELSCL
pag. 216



specchio Eos
Eos mirror
107 x 67 x 4 cm - SPEOL
pag. 220



specchio Eos-c
Eos-c mirror
107 x 67 x 13 cm - SPEOBL
pag. 224



specchio Simple Tall Box
Simple Tall Box mirror
110 x 45 x 12 cm - SPSTB
pag. 228

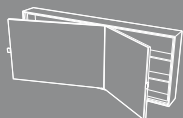

specchio Simple Box
Simple Box mirror
90 x 45 x 12 cm - SPSB
pag. 230

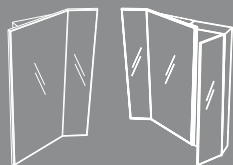

specchio Pan
Pan mirror
cm 74 x 18 x 110 h - SPPAN / SPPANL
cm 37 x 18 x 110 h - SPPANCL
cm 30 x 18 x 110 h - SPPANCC
pag. 232



specchio Round
Round mirror
Ø120 x 4 cm - CASPT
Ø75 x 4 cm - CASPT75
Ø60 x 4 cm - CASPT60
pag. 236



specchio Round Box
Round Box mirror
Ø90 x 12 cm - CASPCT
Ø75 x 12 cm - CASPCT75
pag. 236



specchio Oval
Oval mirror
90 x 50 x 4 cm - CASPO
pag. 242



specchio Oval Box
Oval Box mirror
90 x 50 x 12 cm - CASPCO
pag. 242



Specchio Argo
Argo mirror
40 x 5 x 95 cm
ARSPSA \ ARSPSAL
Pag. 248



Specchio Argo estendibile
Extendable Argo mirror
40 x 5 x 130\190 cm
ARSP \ ARSPL
pag. 248



Specchio Pluto
Pluto Mirror
Ø40
pag. 254

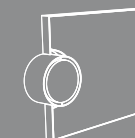

Specchio Polifemo
Polifemo Mirror
cm 90 x 7 x 60 h
pag. 262



specchio Le Giare
Le Giare mirror
87 x 62 x 2,5 cm - LGSP



specchio Elle Tonda
Elle Tonda mirror
110 x 50 x 4 cm



specchio Elle Ovale
Elle Ovale mirror
110 x 70 x 4 cm



specchio elio slim \
elio slim mirror



specchi elio e pluto \
elio and pluto mirror

Materiali e finiture \ Materials and finishes

Elio: dimensioni \ sizes - cm 140 x 50 x 31

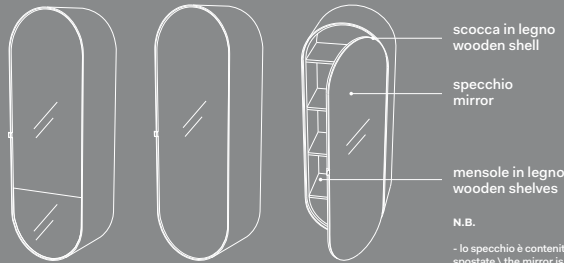

scocca in legno
wooden shell

specchio
mirror

mensole in legno
wooden shelves

N.B.

- lo specchio è contenitore e all'interno ci sono 4 mensole, che hanno la possibilità di essere spostate \ the mirror is a cabinet with 4 shelves inside, with the possibility of moving them

- lo specchio bicolore ha 2 versioni, con apertura a destra o a sinistra \ the two-tone mirror has 2 versions and can be installed with the door opening to the right or left

- lo specchio a tutto vetro è reversibile e si può installare con apertura dell'anta a destra o a sinistra \ the all-glass mirror is reversible and can be installed with the door opening to the right or left

Elio Slim: dimensioni \ sizes - cm 140 x 50 x 12,8

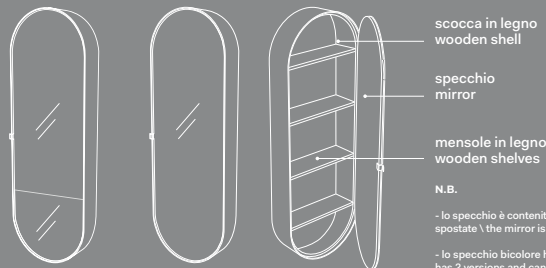

scocca in legno
wooden shell

specchio
mirror

mensole in legno
wooden shelves

N.B.

- lo specchio è contenitore e all'interno ci sono 4 mensole, che hanno la possibilità di essere spostate \ the mirror is a cabinet with 4 shelves inside, with the possibility of moving them

- lo specchio bicolore ha 2 versioni, con apertura a destra o a sinistra \ the two-tone mirror has 2 versions and can be installed with the door opening to the right or left

- lo specchio a tutto vetro è reversibile e si può installare con apertura dell'anta a destra o a sinistra \ the all-glass mirror is reversible and can be installed with the door opening to the right or left

Elio

materiale \ material:
vetro e legno laccato \ glass
and lacquered wood

laccature scocca \ shell
lacquers

● Nero Matt \ Matt Black

porzione bassa specchio \
bottom mirror

● Oro \ Gold

tipo di installazione \
installation



sospesa \ wall-hung

Elio Slim

materiale \ material:
vetro e legno laccato \ glass
and lacquered wood

laccature scocca \ shell
lacquers

● Nero Matt \ Matt Black

porzione bassa specchio \
bottom mirror

● Oro \ Gold

tipo di installazione \
installation



sospesa \ wall-hung



specchio eos \\
eos mirror



Materiali e finiture \ Materials and finishes

Specchio Eos \ Eos mirror: dimensioni \ sizes - cm 67 x 4 x 107 h

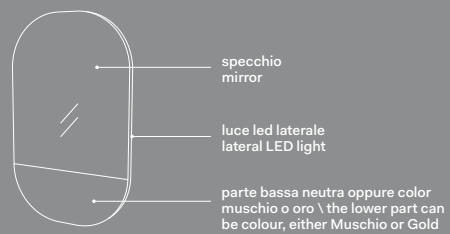

Eos

finiture parte bassa specchio
\ bottom mirror finishes

-  Muschio
-  Oro \ Gold

tipo di installazione \
installation



sospesa \ wall-hung



specchio eos-c \
eos-c mirror



Materiali e finiture \ Materials and finishes

Eos-c: dimensioni \ sizes - cm 107 x 67 x 13

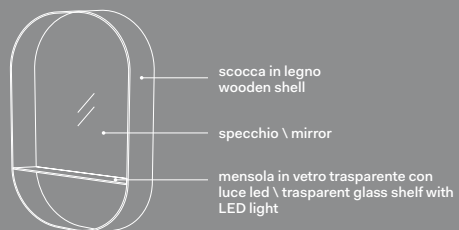

Eos-c

materiale \ material:
 vetro e legno laccato \ glass
 and lacquered wood

laccature scocca \
 boxlacquering

● Nero Matt \ Matt Black

tipo di installazione \
 installation



sospesa \ wall-hung



specchio simple tall box \\
simple tall box mirror



Materiali e finiture \ Materials and finishes

Specchio contenitore reversibile Tall box \ Tall box mirror cabinet - cm 45 x 12 x h110

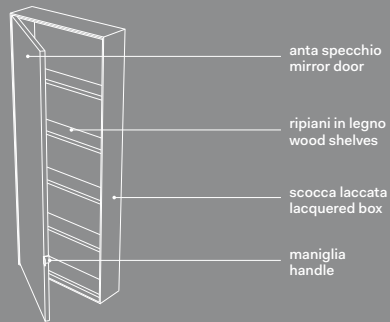

Specchio contenitore Simple box \ Simple box mirror cabinet - cm 90 x 12 x h45

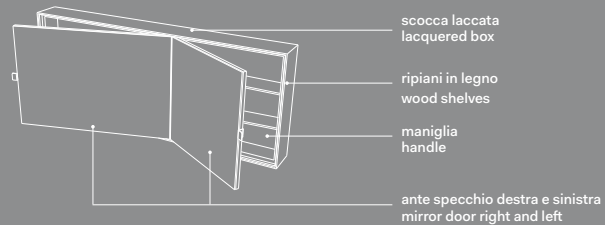

Tall box

finiture cornice \
frame finishes

finiture scocca /
box finishes

-  Cemento
-  Nero Matt \ Matt Black
-  Bronzo Spazzolato \
Brushed Bronze

tipo di installazione \
installation



sospesa \ wall-hung

Simple Tall box

finiture cornice \
frame finishes

finiture scocca /
box finishes

-  Cemento
-  Nero Matt \ Matt Black
-  Bronzo Spazzolato \
Brushed Bronze

tipo di installazione \
installation



sospesa \ wall-hung



specchio pan \\
pan mirror



Materiali e finiture Materials and finishes

Specchio Pan reversibile \ Reversible Pan mirror - cm 74 x 18 x 110 h, 37 x 18 x 110 h, h 30 x 18 x 110

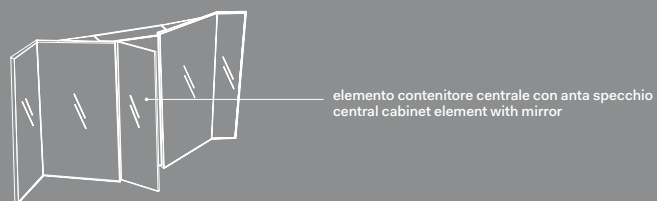
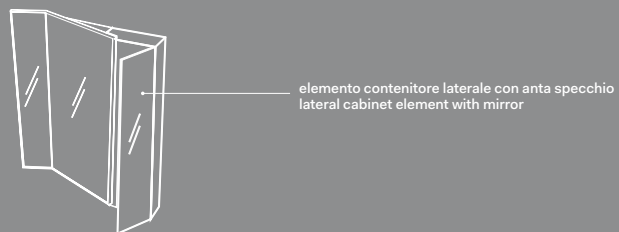
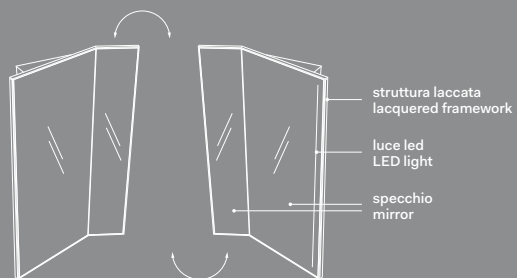

Pan

finiture cornice \
frame finishes

laccature scocca \
boxlacquering

- Nero Matt \ Matt Black
- Acciaio Lucido \ Gloss steel

tipo di installazione \
installation



sospesa \ wall-hung



specchio round \\
round mirror





specchio round box \\
round box mirror



Materiali e finiture \ Materials and finishes

Specchio tondo \ Round mirror - Ø120 x 4 cm, Ø75 x 4 cm, Ø60 x 4 cm

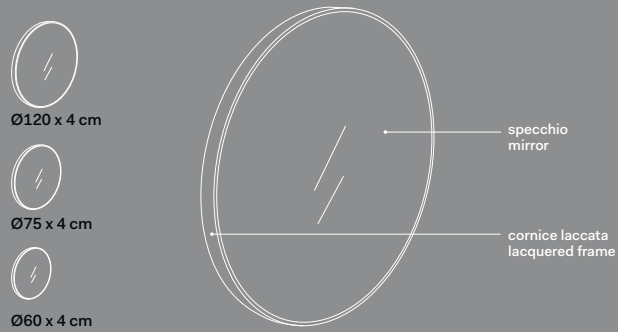

Specchio contenitore Round box \ Round box mirror cabinet - Ø90 x 12 cm, Ø75 x 12 cm

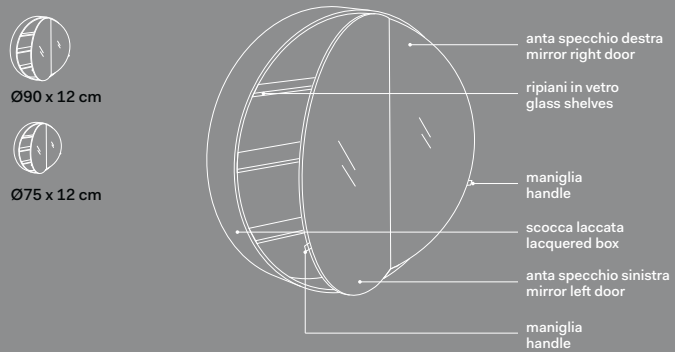

Round

finiture cornice \
frame finishes

laccature \ lacquering

- Cemento
- Nero Matt \ Matt Black
- Bronzo Spazzolato \
Brushed Bronze

Round Box

finiture scocca \
box finishes

laccature \ lacquering

- Cemento
- Nero Matt \ Matt Black
- Bronzo Spazzolato \
Brushed Bronze

tipo di installazione \
installation



sospesa \ wall-hung

tipo di installazione \
installation



sospesa \ wall-hung

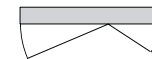

N.B. non reversibile \
not reversible

specchio oval \\
oval mirror





specchio oval box \\
oval box mirror



Materiali e finiture \ Materials and finishes

Specchio ovale \ Oval mirror - cm 90 x 50 x 4

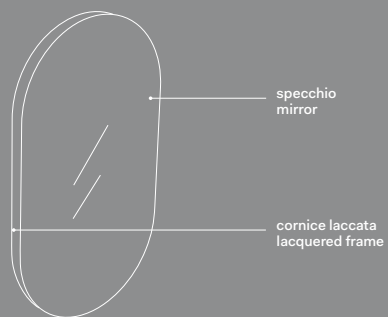

Specchio contenitore Oval box \ Oval box mirror cabinet - cm 90 x 50 x 12

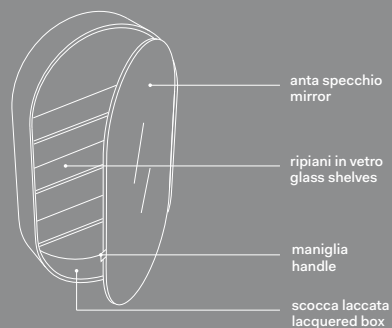

Oval

finiture cornice \
frame finishes

laccature \ lacquering

-  Cemento
-  Nero Matt \ Matt Black
-  Bronzo Spazzolato \
Brushed Bronze

Oval Box

finiture cornice \
frame finishes

laccature \ lacquering

-  Cemento
-  Nero Matt \ Matt Black
-  Bronzo Spazzolato \
Brushed Bronze

tipo di installazione \
installation



sospesa \ wall-hung

tipo di installazione \
installation



sospesa \ wall-hung



N.B. non reversibile \
not reversible



specchio argo senza
luce led e con asta
telescopica \\
extendable argo mirror
without LED light



specchio argo con luce
led e con asta telescopica \\
extendable argo mirror
with LED light



specchio argo a parete
senza luce led \\
wall-hung argo mirror
without LED light



specchio argo a parete
senza luce led \\
argo mirror without LED light

Materiali e finiture Materials and finishes

Specchio Argo a parete con o senza luce led \ Argo wall-mounted mirror, with or without led light - 40 x 95 x 5 cm

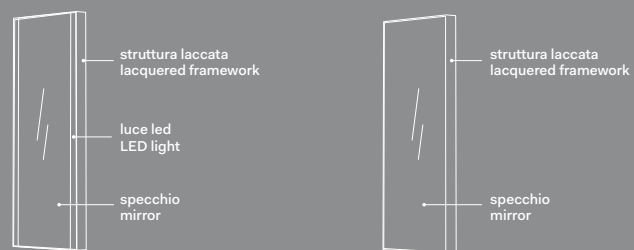

Specchio Argo telescopico con o senza luce led \ Extendable Argo mirror with or without led lighting - 40 x 130/190 x 5 cm

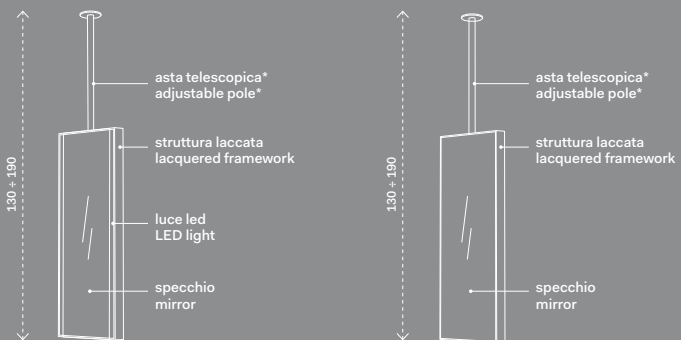

*asta regolabile di 5 in 5 cm \ adjustable pole 5 in 5 cm

Argo wall

finiture struttura \
framework finishes

laccature \ lacquering



Argo extendable

finiture struttura \
framework finishes

laccature \ lacquering

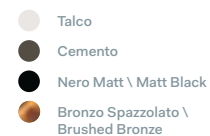

tipo di installazione \
installation



sospesa \ wall-hung

tipo di installazione \
installation



a soffitto \
ceiling installation

specchio pluto
senza luce led \ pluto
mirror without LED light



specchio pluto
con luce led \ pluto
mirror with LED light



specchio pluto
con luce led \\
pluto mirror with
led light





Materiali e finiture \ Materials and finishes

Specchio Pluto con o senza luce led \ Pluto mirror with or without led light - Ø40

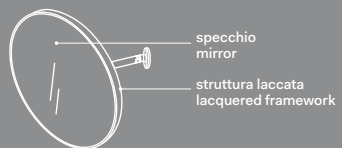
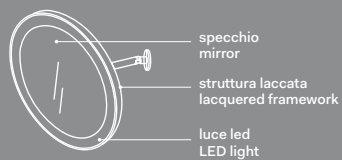

Pluto light

finiture struttura \
framework finishes

laccature \ lacquering



tipo di installazione \
installation



sospesa \ wall-hung

Pluto

finiture struttura \
framework finishes

laccature \ lacquering

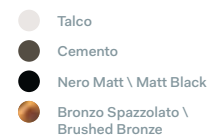

tipo di installazione \
installation



sospesa \ wall-hung



specchio polifemo \\
polifemo mirror

Materiali e finiture \ Materials and finishes

Specchio Polifemo con luce led \ Polifemo mirror with led light - 90 x 60 x 7 cm

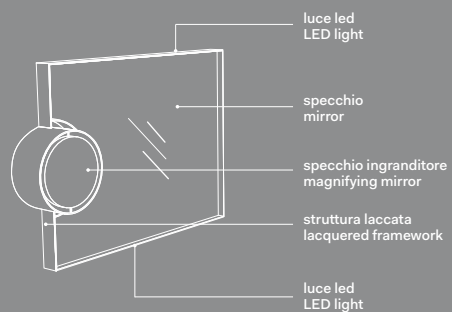

Polifemo

finiture struttura \
 framework finishes

laccature \ lacquering

- Talco
- Cemento
- Nero Matt \ Matt Black
- Bronzo Spazzolato \
Brushed Bronze

tipo di installazione \
 installation



sospesa \ wall-hung

i colori \ the colours: le terre di cielo.

“Tra tutte le qualità, il colore è quella di cui è più difficile parlare”

“Above all, color is the most difficult to talk about”





«alla domanda “cos'è il colore”
gli antichi avrebbero risposto “una
qualità soggettiva”

if asked “what is colour”, the
ancients would have answered “a
subjective quality”»

Il colore come esperienza tattile

Alla domanda “cos'è il colore” gli antichi avrebbero risposto “una qualità soggettiva”; oggi la risposta scientifica potrebbe essere “l'apprezzamento di una radiazione visibile”. In ogni caso il colore si manifesta come esperienza sensoriale dell'osservatore, associata normalmente al senso della vista. Fermandoci a riflettere sulla sensazione ricevuta dall'osservazione di ciascun colore, dal freddo al caldo, ci rendiamo tuttavia conto che alla vista si associa conseguentemente anche il senso del tatto, che contribuisce in maniera determinante all'accentuazione della sensazione data da un determinato fattore cromatico.

Una superficie levigata di un determinato colore non darà a chi la osserva e la tocca la stessa sensazione rispetto a una superficie scabra e ruvida.

Colour as tactile experience

If asked “what is colour”, the ancients would have answered “a subjective quality”. Today the scientific answer could be “the appreciation of a visible radiation”. In any case, colour is manifested as a sensorial experience of the observer, normally associated with the sense of sight. But if we consider for a moment the feelings we get when we look at each colour, from warm to cold, we realize that the sense of sight is also linked to that of touch, which plays a determinant role in reinforcing the sensation created by a certain chromatic factor. A polished and smooth surface of a certain colour will not give those who look at it and touch it the same sensation as an uneven and rough one.



«...La natura come matrice cromatica. Colori e suoni appartengono alla natura [...] sono il linguaggio stesso della natura.

...Nature as chromatic matrix. Colours and sounds belong to nature [...] they are the very language of nature»

“Colori e suoni appartengono alla natura” scriveva Goethe nella sua Teoria dei colori, “[...] essi sono fenomeni naturali [...] sono il linguaggio stesso della natura”. La natura è colore, gli elementi vegetali e minerali, le rocce, le piante, gli animali, si contraddistinguono in base al loro colore e alla loro conformazione. Il legame intrinseco tra colore e natura deve guidare indissolubilmente, secondo Goethe, l’atteggiamento dell’uomo nei confronti dei colori, che partecipano attivamente alle esperienze sensoriali attraverso una propria forma di comunicazione.

Già nell’antichità l’opinione più diffusa sosteneva che i colori incorporati dell’arcobaleno si sostanziassero in quelli della natura, in particolare nelle pietre preziose e nei loro sostituti, smalti e paste vitree. Alla componente naturalistica del colore si rifanno anche molti dei nomi che questi hanno assunto nel corso dei secoli mostrando, una volta di più, il riferimento naturale di ciascun cromatismo.

“Colours and sounds belong to nature” wrote Goethe in his Theory of colours, “[...] they are natural phenomena [...] they are the very language of nature”.

Nature is colour; vegetal and mineral elements, stones, plants and animals are characterized on the basis of their colours and conformations.

According to Goethe, the intrinsic bond between colour and nature must indissolubly guide Man’s attitude to colour, which plays an active role in sensorial experiences through an own form of communication.

Already in antiquity it was widely held that the ethereal colours of the rainbow assumed tangible form in those of nature, especially in precious stones and their substitutes, glass glazes and paste. Many of the names that colours have been given in the course of the centuries can also be retraced to their naturalistic component: another conformation of the natural associations of each chromatic shade.



« I colori hanno una loro vita propria, si trovano anche nella parte interna delle conchiglie assopite nelle profondità marine »

«Colours live a life of their own; they are also found inside conches resting on the bottom of the ocean »

La gamma di colori proposta da Cielo è il risultato di veri e propri esperimenti alchemici dove la chimica è messa al servizio della sensibilità espressiva. Una sapiente selezione di ossidi di origine metallica e minerale, scelti specificatamente per ciascuna tonalità, in aggiunta alla miscela di base dello smalto porta alla creazione dei nuovi colori della collezione: così è il cadmio selenio per il rosso, il cobalto per il blu, il manganese per il marrone, il cromo per il verde, il praseodimio per il giallo.

Lo smalto colorato, una volta testato, è quindi pronto per essere spruzzato sulla superficie semi-lavorata dei pezzi essiccati e per diventarne parte integrante in seguito alla cottura a temperature che vanno dai 1230 ai 1250°C. Un attento procedimento scientifico si mostra anche in questo caso capace di rispondere a libertà espressive che rendono l'utilizzo degli elementi sanitari singoli esperienze sensoriali.

The colour range presented by Cielo is the result of true alchemic experiments where chemistry has been placed at the service of expressive sensibility. A judicious selection of oxides of metallic and mineral origin, chosen specifically for each shade, in addition to the basic mixture of glaze, have resulted in the creation of the new colours of the collection: with cadmium selenium for red, cobalt for blue, manganese for brown, chrome for green, praseodymium for yellow.

Once tested, the coloured glaze is ready to be sprayed onto the semi-finished surface of the dried pieces, and to become an integral part of it after firing at temperatures varying from 1230 to 1250°C. Also in this case an attentive scientific procedure proves capable of meeting the requirements of an expressive freedom that turns the use of bathroom fixtures into singular sensorial experiences.

le 16 nuances \ 16 shades

« alchimia del colore e libertà
espressiva. Alchemy of colour
and expressive freedom »



01\ Talco

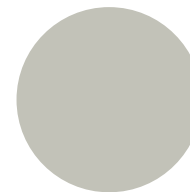

02\ Pomice

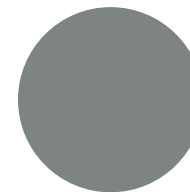

03\ Brina

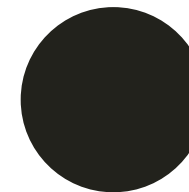

04\ Basalto

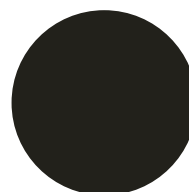

05\ Lavagna

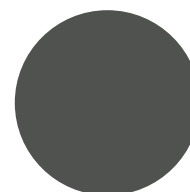

06\ Cemento

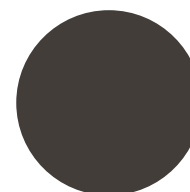

07\ Fango

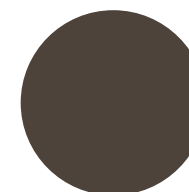

08\ Cacao

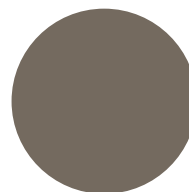

09\ Arenaria

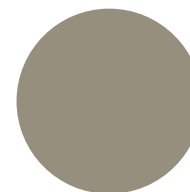

10\ Avena

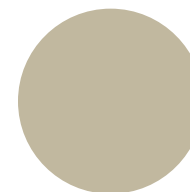

11\ Lino

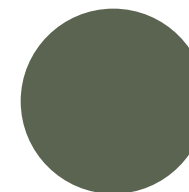

12\ Agave

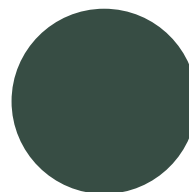

13\ Muschio

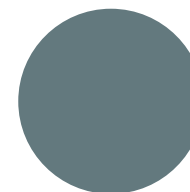

14\ Polvere

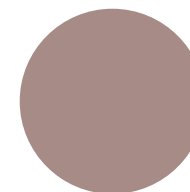

15\ Cipria

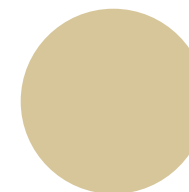

16\ Canapa

01\ Talco



Scaglie e piccoli cristalli minerali si trasformano in morbida polvere di un bianco latte contaminato da punte brunastre.

Mineral flakes and small crystals turn into a soft, milky white powder contaminated by brownish points.

06\ Cemento



La durissima 'pietra' artificiale, generata da una morbida pasta di polvere e acqua, assume un elegante colore grigio intenso che si fonde con pigmenti testa di moro.

This extra-hard artificial "stone", made out of a soft paste of powder and water, takes on an intense gray hue blending with dark brown tone.

09\ Arenaria



L'origine sedimentaria dell'arenaria unisce le tonalità del grigio in un unico, elegante colore, identificativo della sua natura litica.

The sedimentary origin of sandstone combines different shades of grey in a single, elegant colour which bears witness to its lithic nature.

14\ Polvere

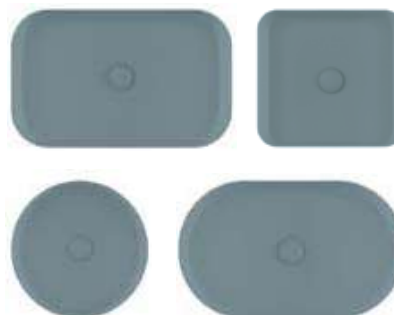

Dal ciano al violetto, dalle sfumature più fredde del grigio all'azzurro del cielo. Una nuance raffinata in piena armonia con la natura.

From cyan to violet, with cooler overtones of gray and sky blue. A refined hue in complete harmony with nature.

08\ Cacao

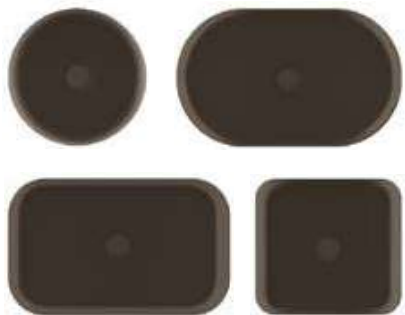

Un lungo processo di lavorazione trasforma il porpora della mandorla contenuta nel frutto del cacao nel caratteristico colore bruno toccato da una punta di ocra.

A long process transforms the purple of the almond inside the cocoa fruit into the characteristic brown shade with a touch of ochre.

15\ Cipria



Il rosa naturale della cipria picchiettato da residui di minerali si associa alla texture vellutata della sua struttura a grana finissima.

The natural pink of powder flecked from mineral residues, match with the velvety texture of its very fine-grained structure.

16\ Canapa

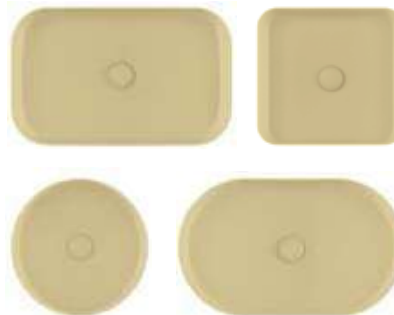

E' una fibra tessile primordiale e prestigiosa, dalle mille risorse. Con le sue sfumature di giallo, grigio e tortora evoca una bellezza senza tempo.

It is a primordial and precious textile fiber with a thousand possibilities for use. With its shades of yellow, gray and dove-grey, it evokes timeless beauty.

13\ Muschio



Il verde del muschio di sottobosco evoca sensazioni primordiali associate alla morbida tattilità della sua superficie.

The intense green of the moss found in forest undergrowth evokes primordial sensations associated with the tactile softness of its surface.

05\ Lavagna

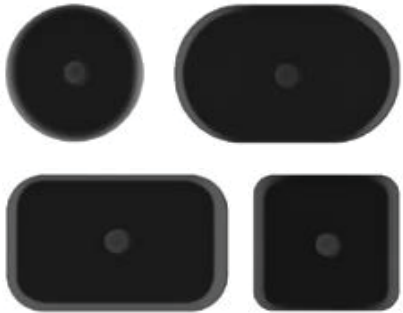

Il grigio-nero profondo della roccia argillosa si affianca alla sottile asprezza della sua superficie sfaldabile.

The deep gray-black of this clay-based rock is paired by the subtle roughness of its foliated surface.

02\ Pomice



Il grigio tenue della pietra pomice si associa alla sottile scabrosità della sua superficie porosa.

The light grey colour of the pumice stone is associated with the subtle roughness of its porous surface.

03\ Brina



L'aspetto candido della brina si confonde con la sua superficie cristallina e granulosa, fatta di scaglie di morbido ghiaccio.

The whiteness of the frost is hard to distinguish from its crystalline and granular surface, made from soft ice flakes.

11\ Lino



L'aspetto fresco e morbido del lino si associa alla sua struttura resistente, attenuata da toni chiari e delicati.

Flax's cool, fresh appearance is paired by its sturdy structure, softened by light, gentle hues.

04\ Basalto



L'origine vulcanica del basalto definisce tonalità scure tendenti al blu-oceano, un colore tanto profondo quanto vicino alla superficie del mare e della notte.

It is the volcanic origin of basalt that gives it its distinctive dark nuances tending to sea blue, a colour that is as profound as it is close to the surface of the ocean and the night.

10\ Avena



Le delicate cromaticità dei fiocchi d'avena, giocate su toni caldi e dorati, suggeriscono sensazioni di leggerezza e luminosità.

The subdued tones of oat are infused with touches of warm, golden hues for an impression of lightweight luminosity.

12\ Agave

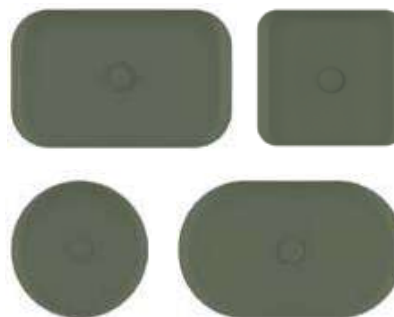

Il verde della foglia d'agave si fonde con il grigio e i toni dell'azzurro evocando le atmosfere del Mediterraneo.

The green shade of the agave leaf blends with grey and blue shades, evoking a Mediterranean atmosphere.

07\ Fango

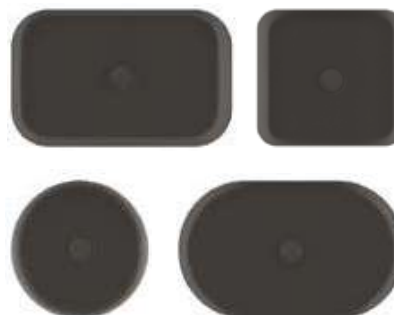

Terra e polvere intrise d'acqua danno vita ad un impasto dai toni neutri, in cui i marroni e i grigi si uniscono in un'unica nuance, accattivante e sensuale.

Earth and dust mix with water to create a mixture of neutral hues, with browns and grays merging in an alluringly sensual tone.



© Tutti i diritti sono riservati.
Nessuna parte di questo catalogo può essere
riprodotta o trasmessa in qualsiasi forma o con
qualsiasi mezzo elettronico, meccanico o altro senza
l'autorizzazione scritta dei proprietari dei diritti.

Ottobre 2019

A.D.
Andrea Parisio e
Giuseppe Pezzano

A.D. Progetto Grafico:
Tommaso Cavallini

Fotografie:
Davide Lovatti

Fotolito e stampa:
TAP Grafiche
Poggibonsi

cielo

Ceramica Cielo Spa

Via Falerina km 7800

01034 - Fabrica di Roma (VT)

t +39 0761 56701 / f +39 0761 540363

info@ceramicacielo.it

www.ceramicacielo.it

Spazio Cielo

Via Pontaccio 6

20121 - Milano Italy

t +39 0239661165